

Date	2022-01-18
	13.8

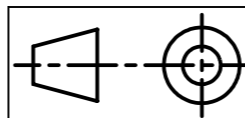

			2022-04-07 16:41:27		20186 Amber 50 (60) Pernilla Nilsson	1/18	A3
	Sheet 1-3	Date				Sheet2	

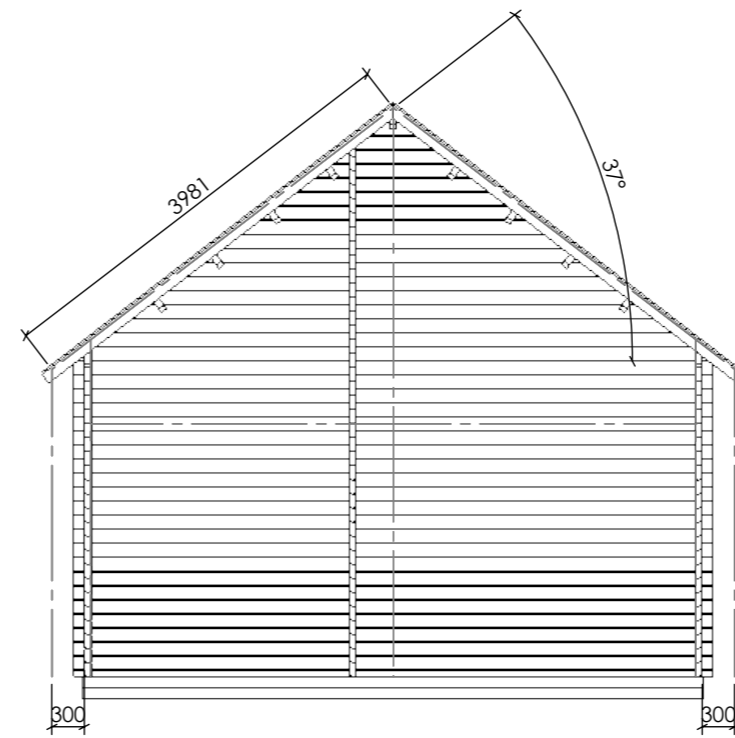
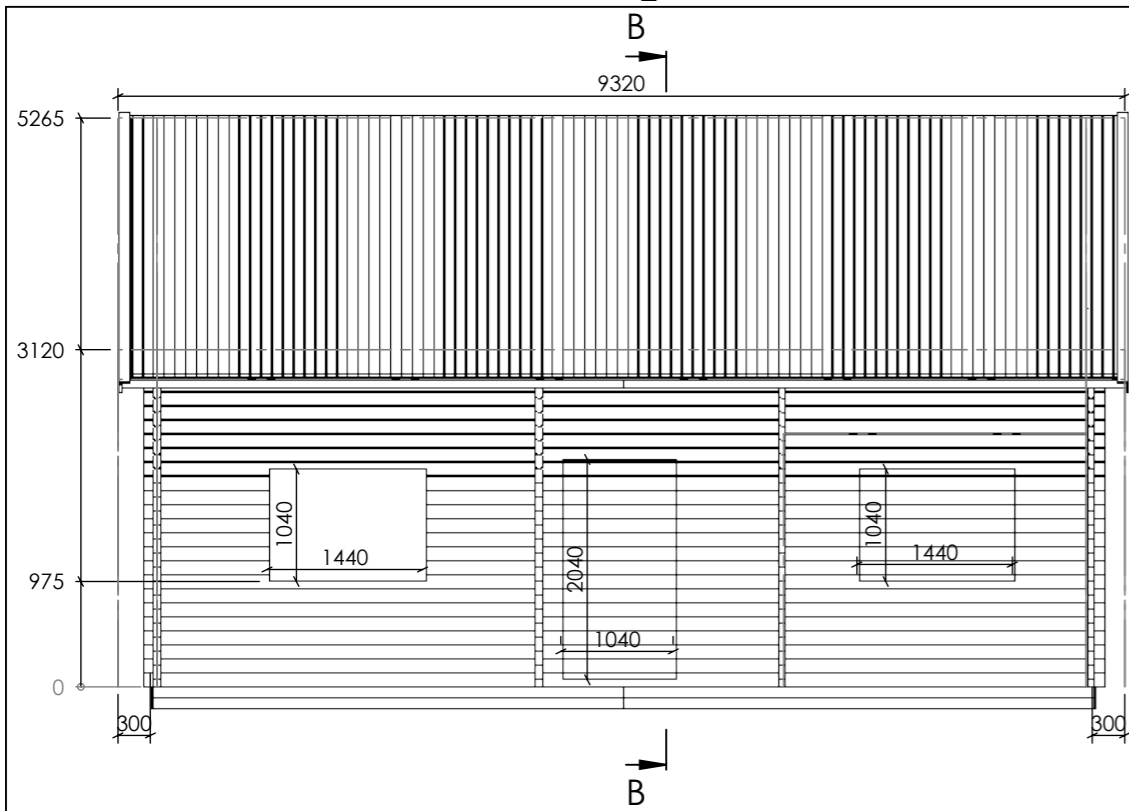

B-B

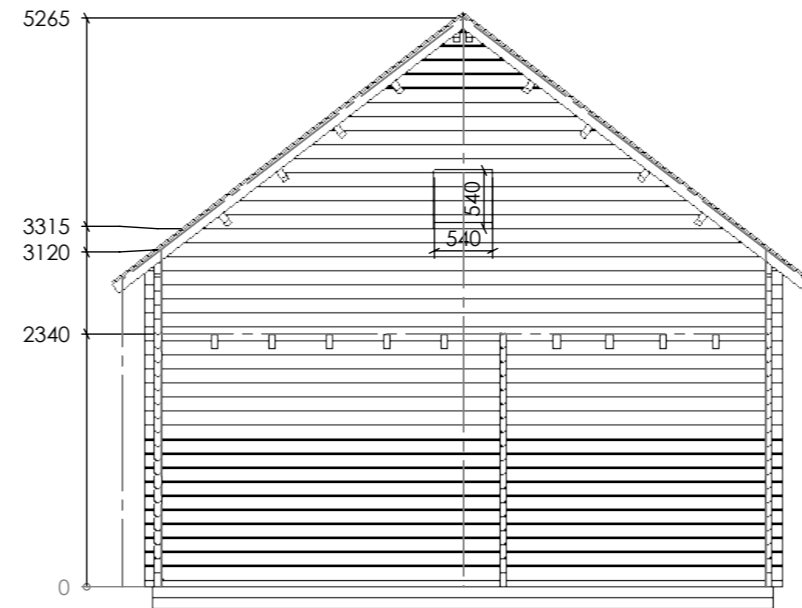
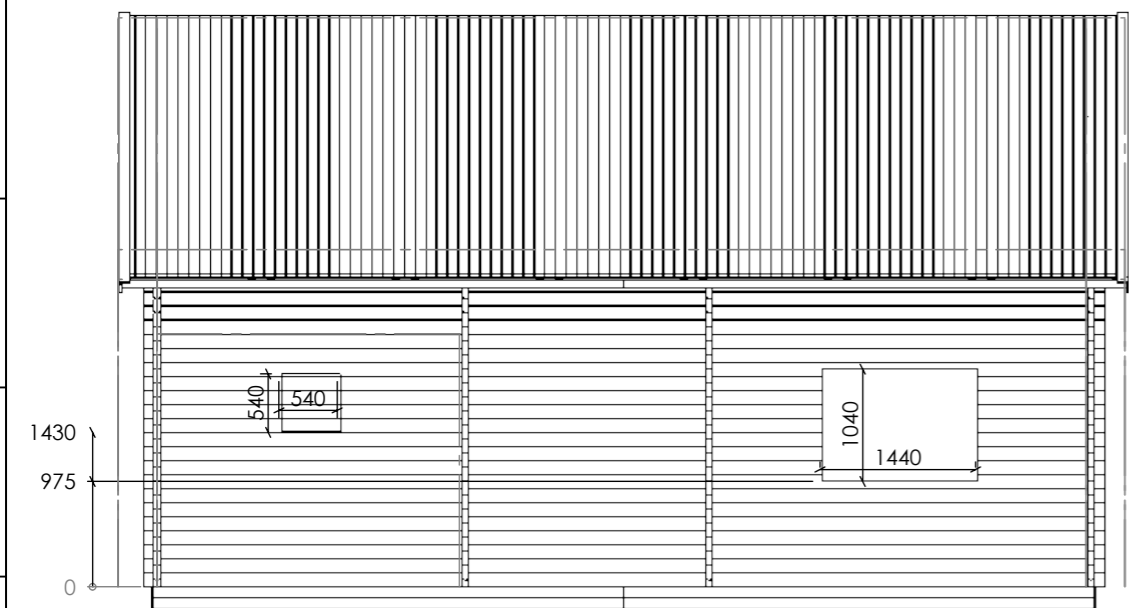

Date	2022-01-18
13.8	

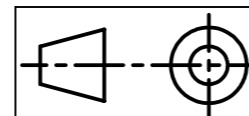

Sheet 2-3

2022-04-07
16:41:27

Date

20186 Amber 50 (60) Pernilla Nilsson

2/18 A3
Sheet1

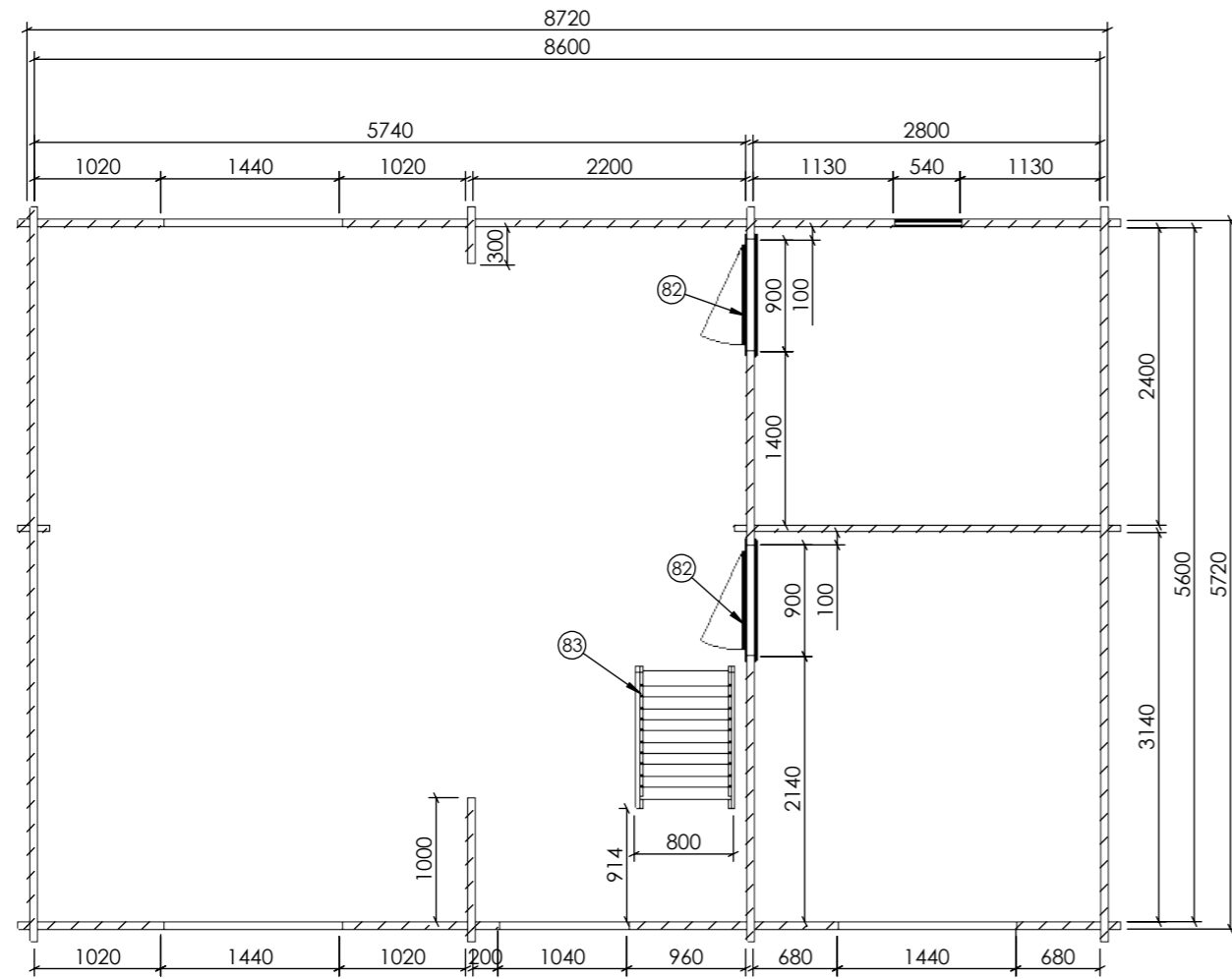

Plan

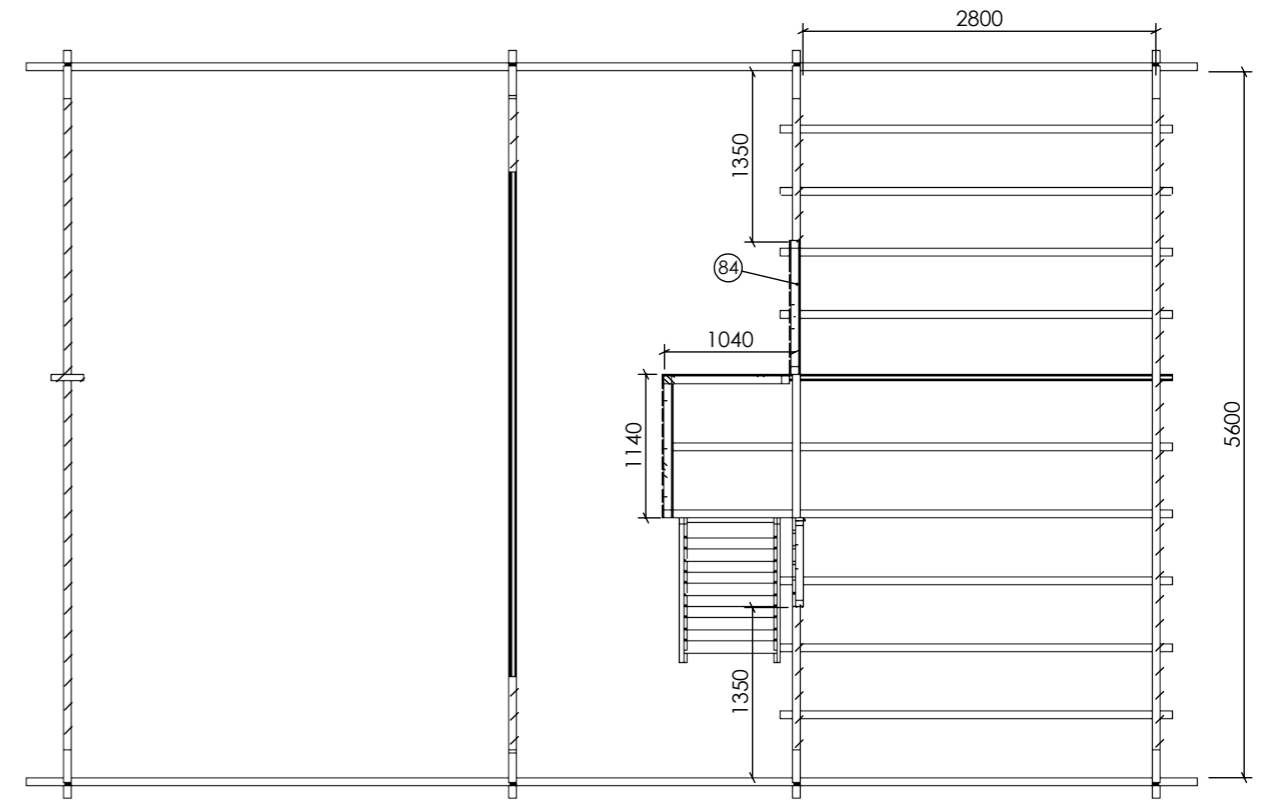

Plan P

Date	2022-01-18
	13.8

ITEM NO.	DESCRIPTION	QTY.
82	Door D52 1980x880	2
83	STAIRS	1
84	FENCE	1

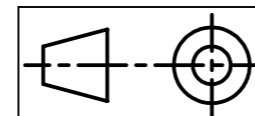

Sheet 3-3

2022-04-07 16:41:27
Date

20186 Amber 50 (60) Pernilla Nilsson

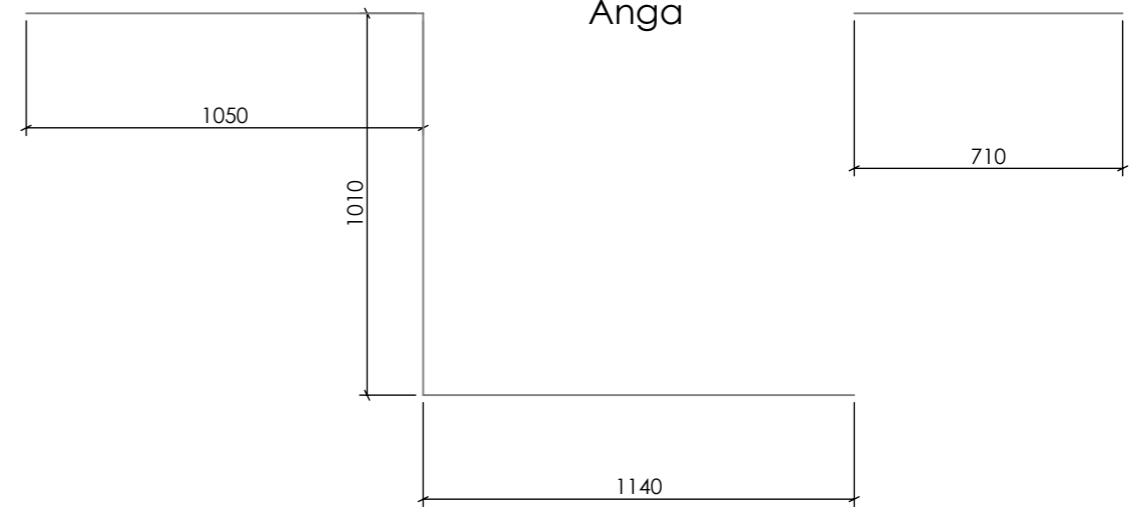
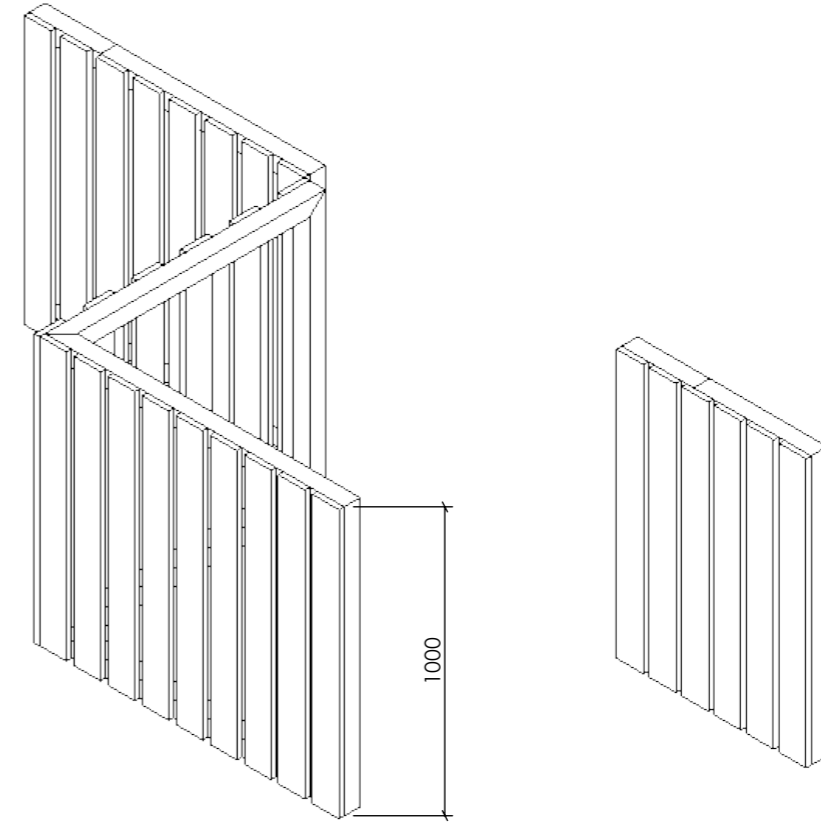
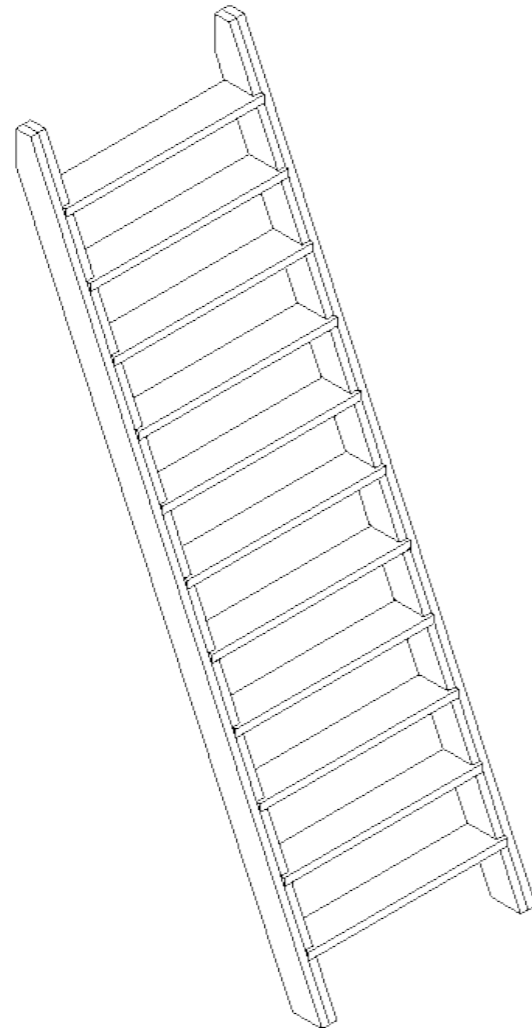
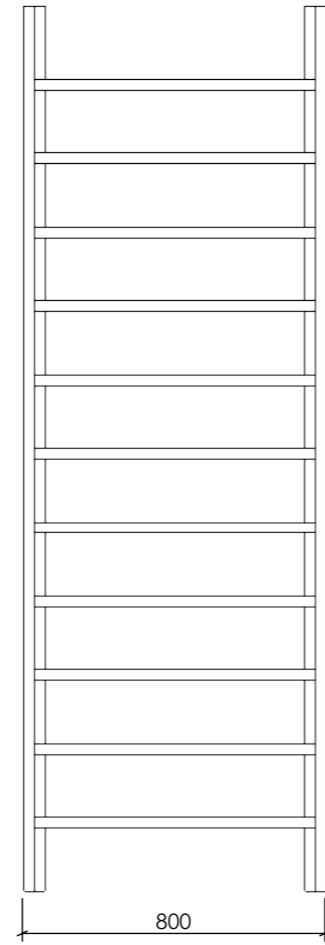
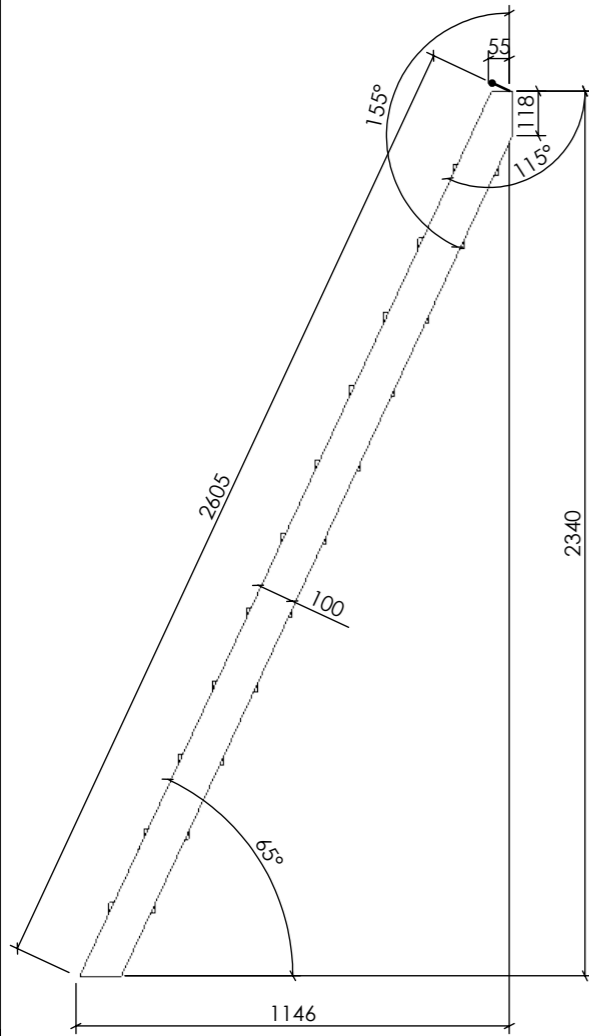

Date	2022-04-07
------	------------

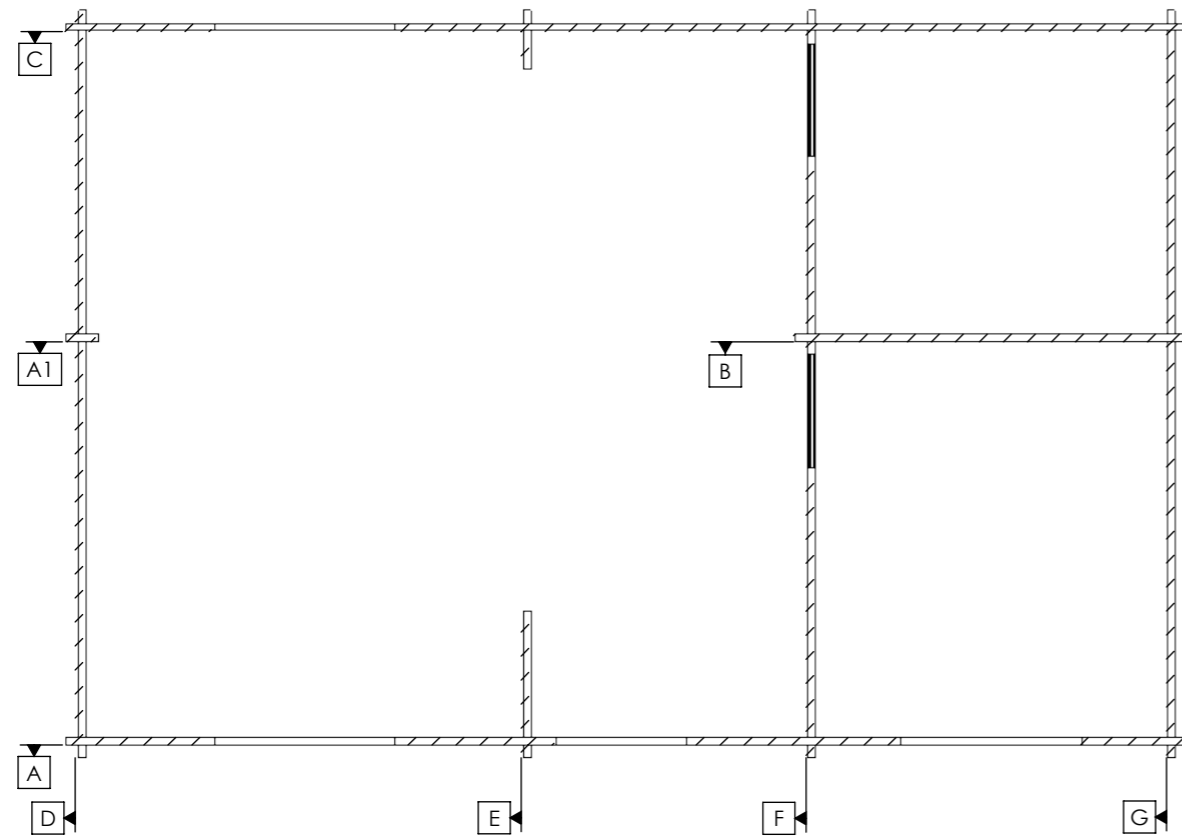

Plan

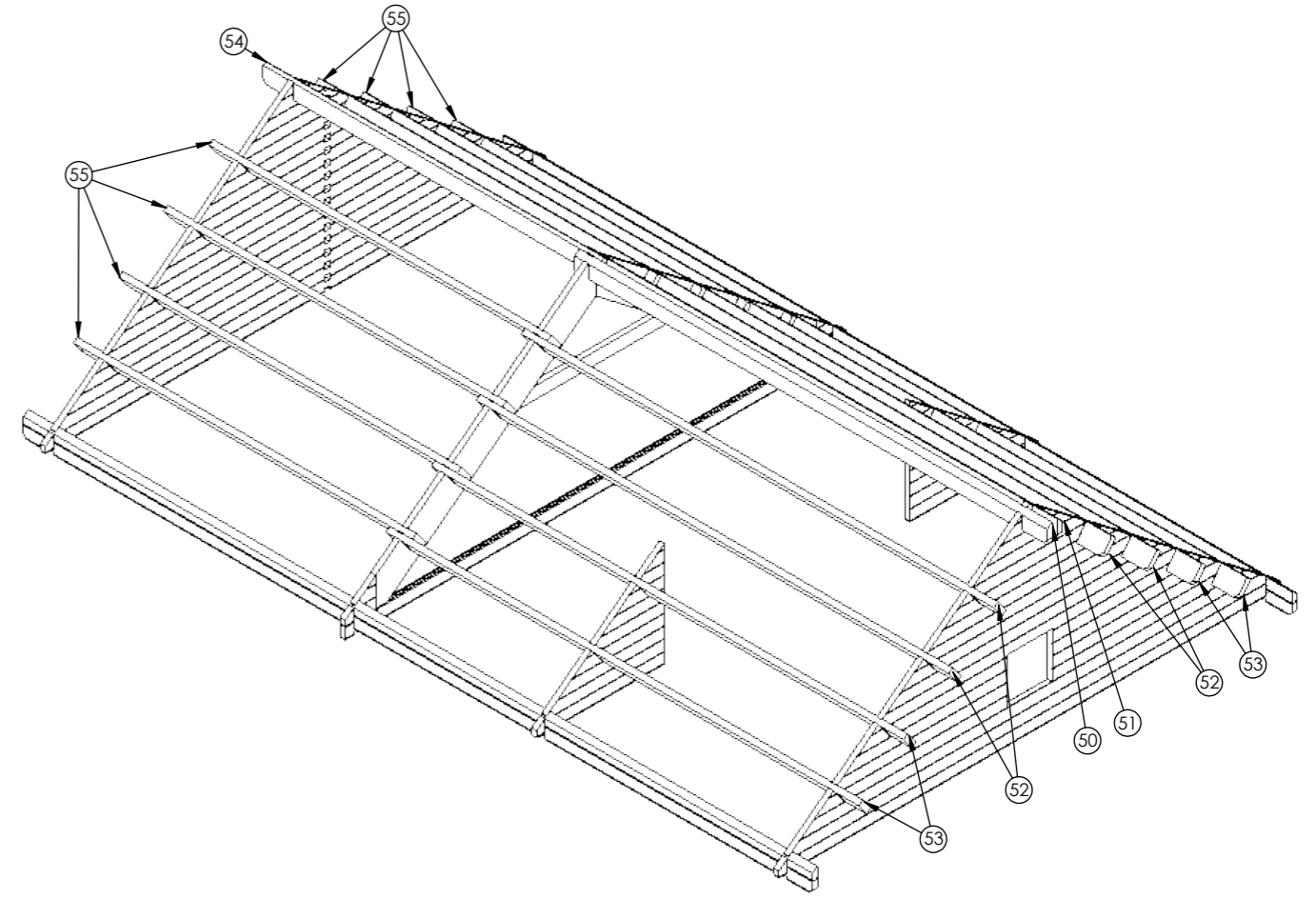

Roof rafters 60x200

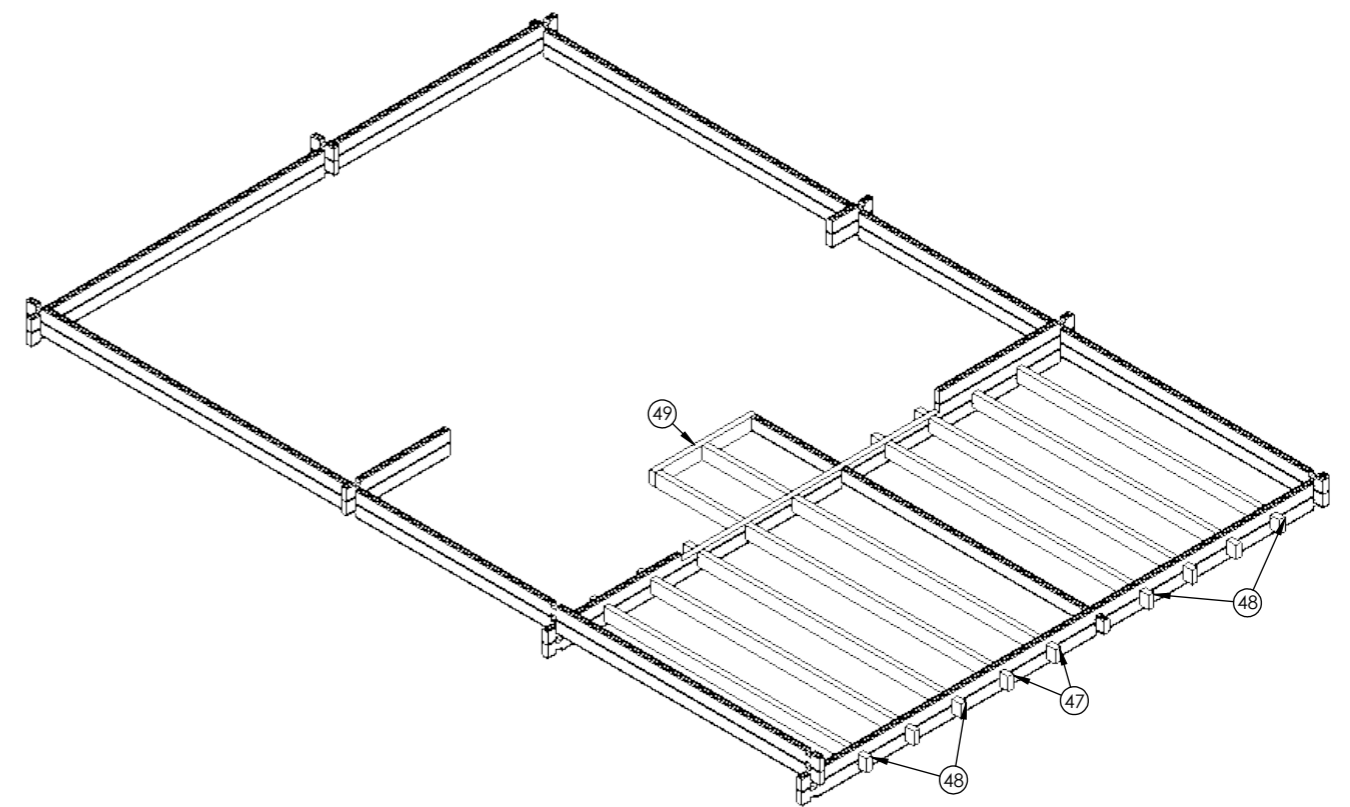

Floor beams 60x140

Date	2022-04-07

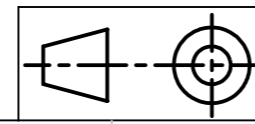

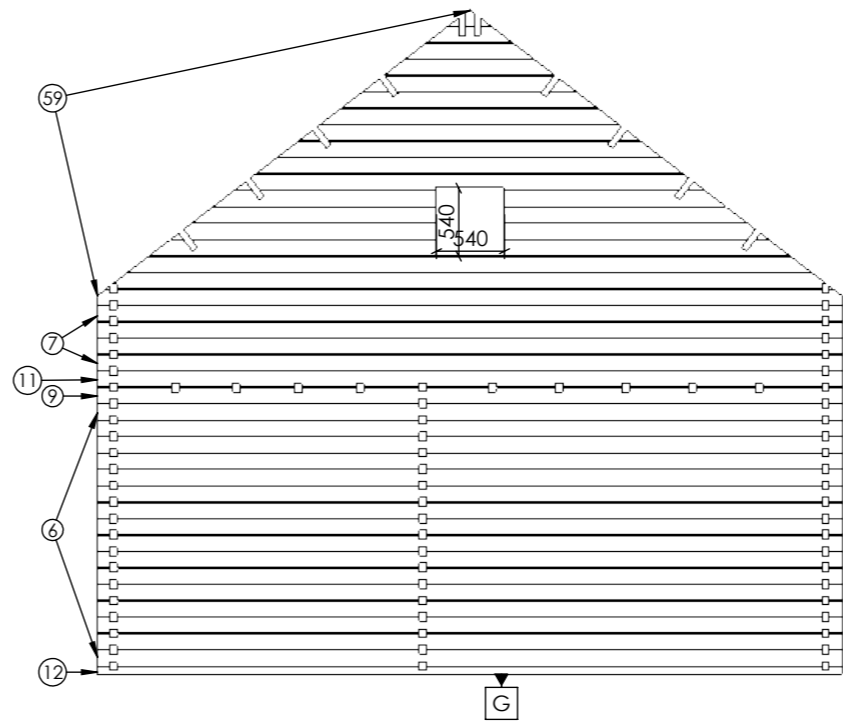
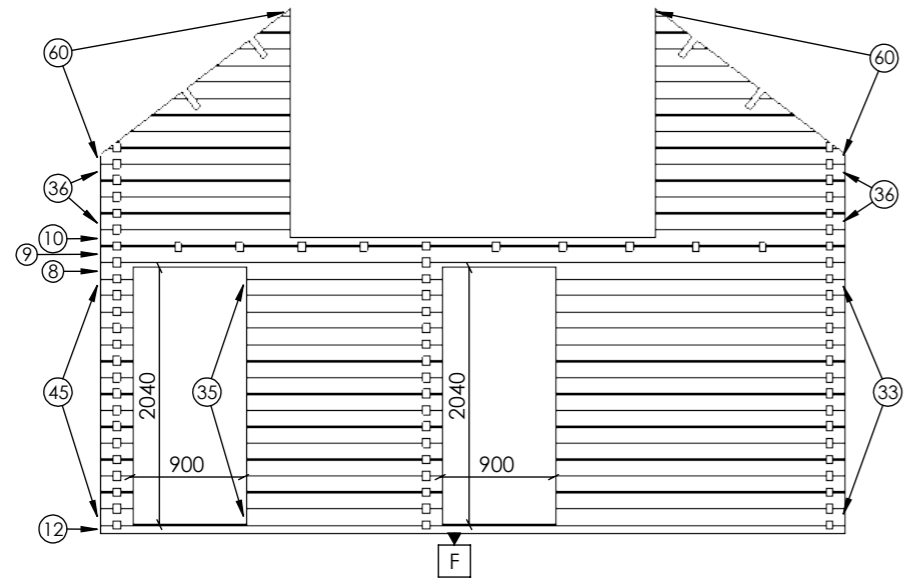
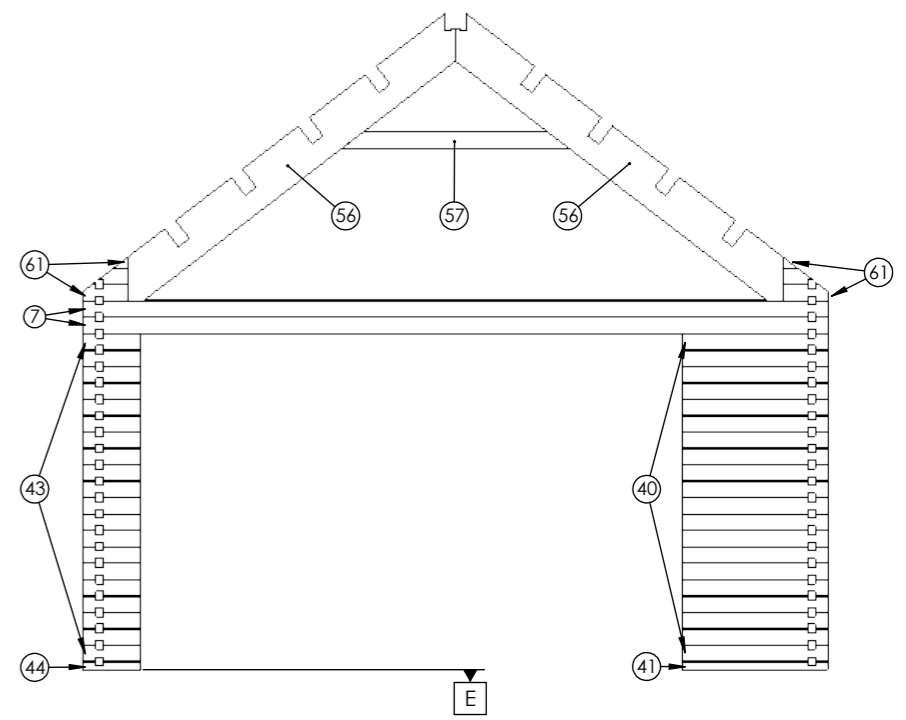
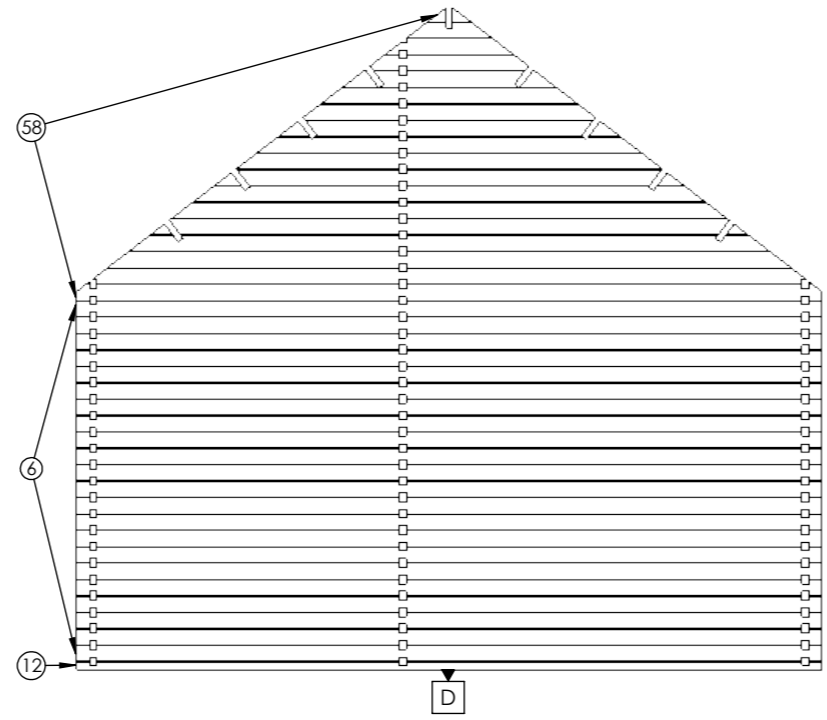
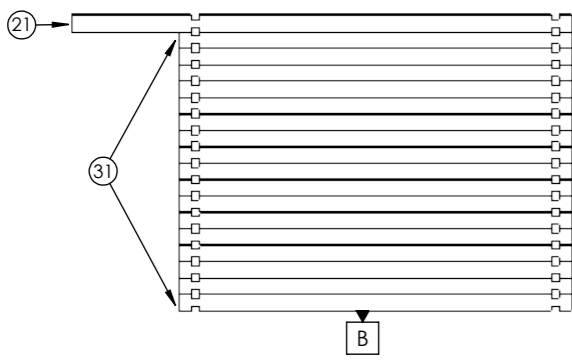
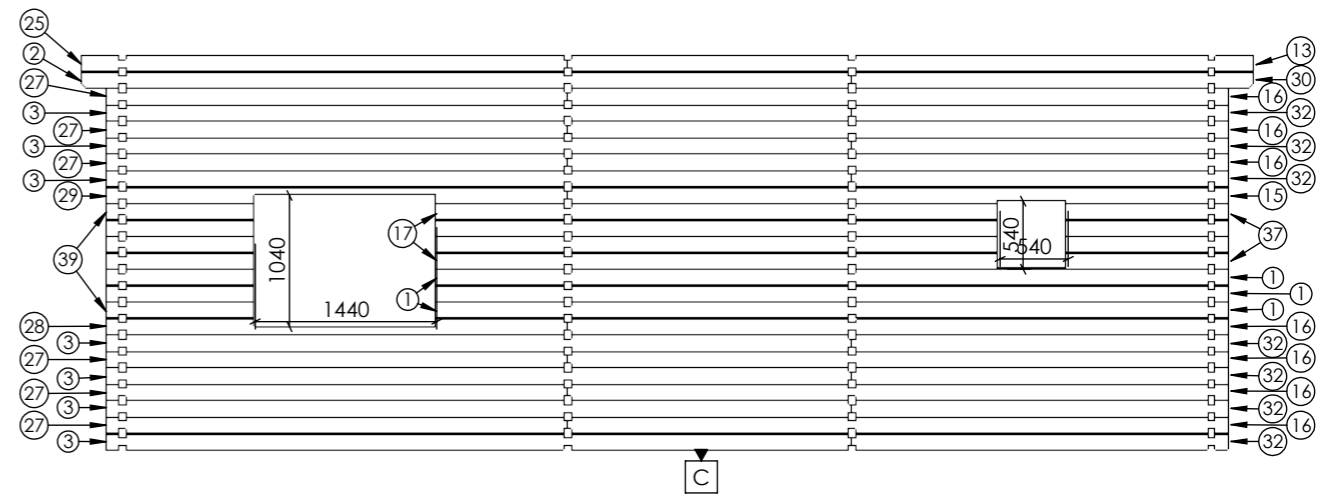
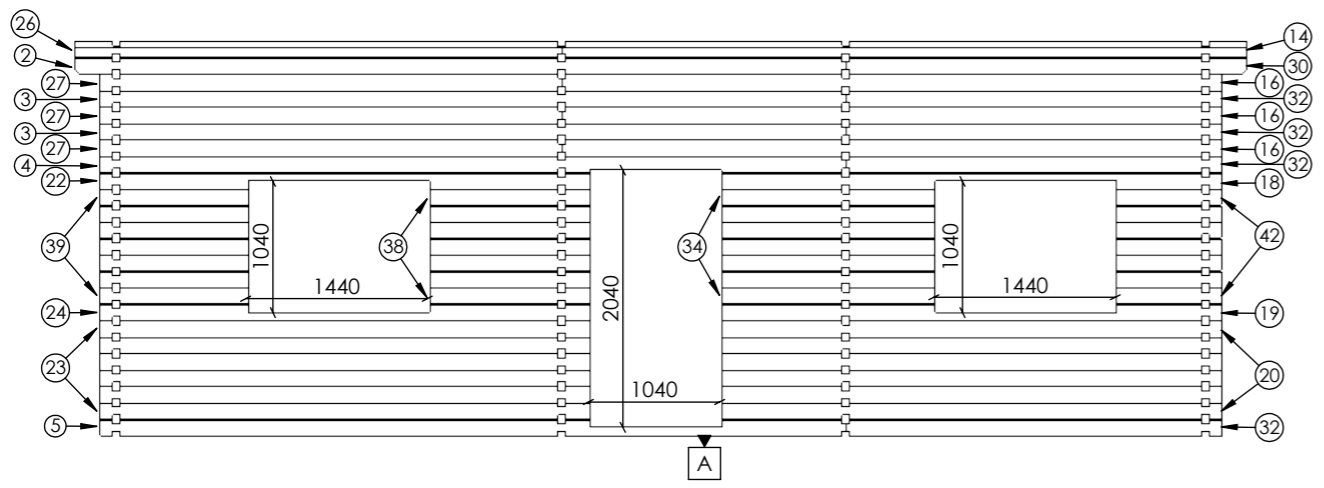

Date	2022-04-07
------	------------

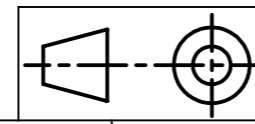

Sheet 2-11

2022-04-07 14:45:17
Date

20186 Amber 50 (60) Pernilla Nilsson [W]

6/18 A3
Walls A;B;C;D;E;F;G;A1

ITEM NO.	QTY.	DESCRIPTION	LENGTH
1	3	SIDE BEAM 130x60	6300
2	2	SIDE BEAM 130x60	6129
3	9	SIDE BEAM 130x60	5929
4	1	SIDE BEAM 130x60	5929
5	1	SIDE BEAM 130x60	5929
6	38	SIDE BEAM 130x60	5920
7	6	SIDE BEAM 130x60	5920
8	1	SIDE BEAM 130x60	5920
9	2	SIDE BEAM 130x60	5920
10	1	SIDE BEAM 130x60	5920
11	1	SIDE BEAM 130x60	5920
12	3	SIDE BEAM 130x60	5920
13	1	SIDE BEAM 130x60	5449
14	1	SIDE BEAM 130x60	5449
15	1	SIDE BEAM 130x60	5249
16	10	SIDE BEAM 130x60	5249
17	4	SIDE BEAM 130x60	4470
18	1	SIDE BEAM 130x60	3980
19	1	SIDE BEAM 130x60	3980
20	6	SIDE BEAM 130x60	3980
21	1	SIDE BEAM 130x60	3970
22	1	SIDE BEAM 130x60	3900
23	6	SIDE BEAM 130x60	3900
24	1	SIDE BEAM 130x60	3900
25	1	SIDE BEAM 130x60	3869

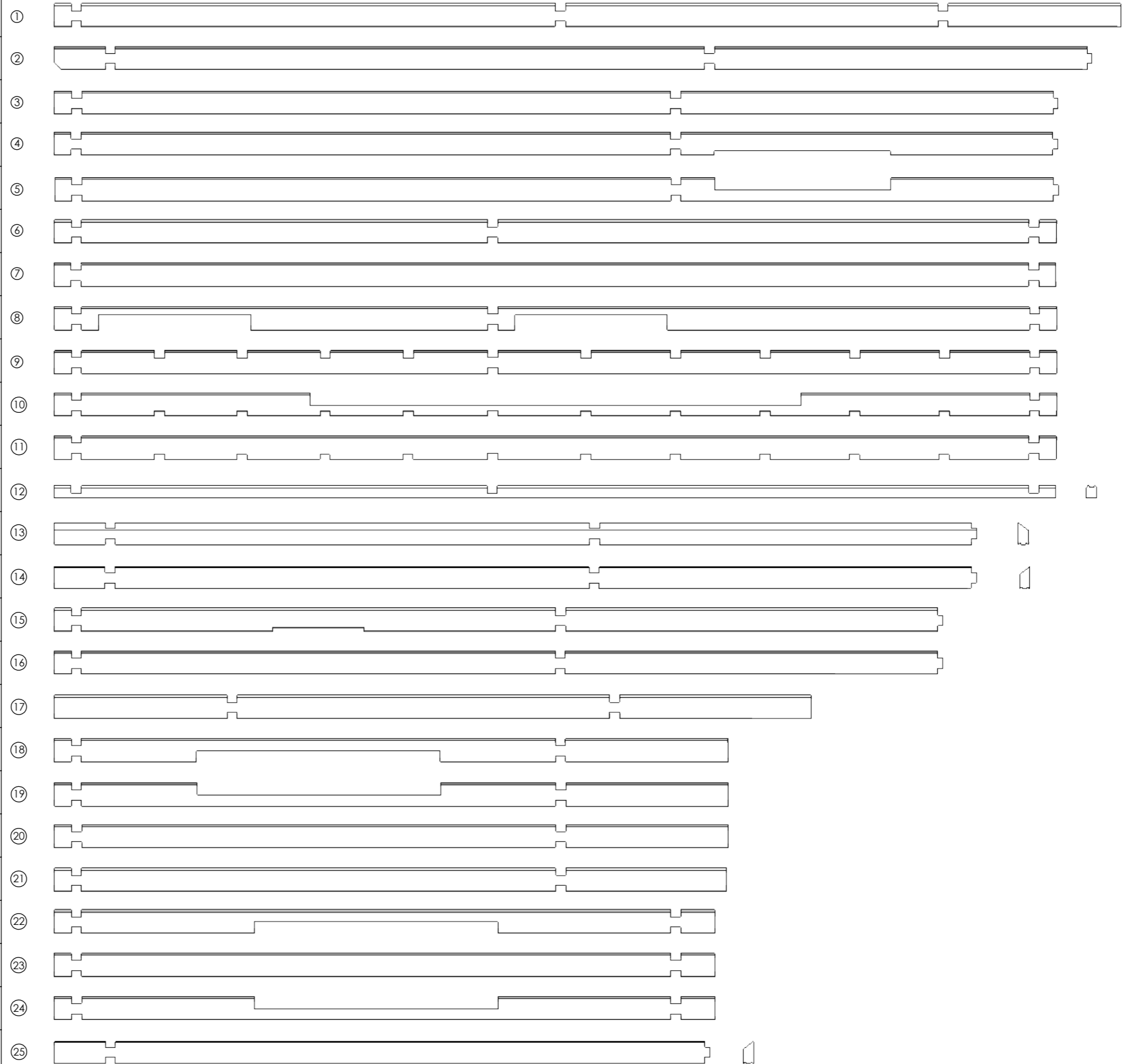

Date
2022-04-07

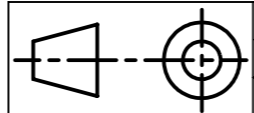

Sheet 3-11

2022-04-07
14:45:17

Date

20186 Amber 50 (60) Pernilla Nilsson [W]

7/18 A3

Pack list 1-25 (1/)

ITEM NO.	QTY.	DESCRIPTION	LENGTH
26	1	SIDE BEAM 130x60	3869
27	9	SIDE BEAM 130x60	3669
28	1	SIDE BEAM 130x60	3669
29	1	SIDE BEAM 130x60	3669
30	2	SIDE BEAM 130x60	3189
31	17	SIDE BEAM 130x60	3120
32	11	SIDE BEAM 130x60	2989
33	15	SIDE BEAM 130x60	2300
34	7	SIDE BEAM 130x60	1700
35	15	SIDE BEAM 130x60	1560
36	8	SIDE BEAM 130x60	1510
37	4	SIDE BEAM 130x60	1290
38	7	SIDE BEAM 130x60	1280
39	14	SIDE BEAM 130x60	1180
40	20	SIDE BEAM 130x60	1160
41	1	SIDE BEAM 130x60	1160
42	7	SIDE BEAM 130x60	840
43	20	SIDE BEAM 130x60	460
44	1	SIDE BEAM 130x60	460
45	53	SIDE BEAM 130x60	260
46	1	SIDE BEAM 130x60	260
47	2	FLOOR BALKS 140x60	3970
48	7	FLOOR BALKS 140x60	3120
49	1	FLOOR BALKS 140x60	1140

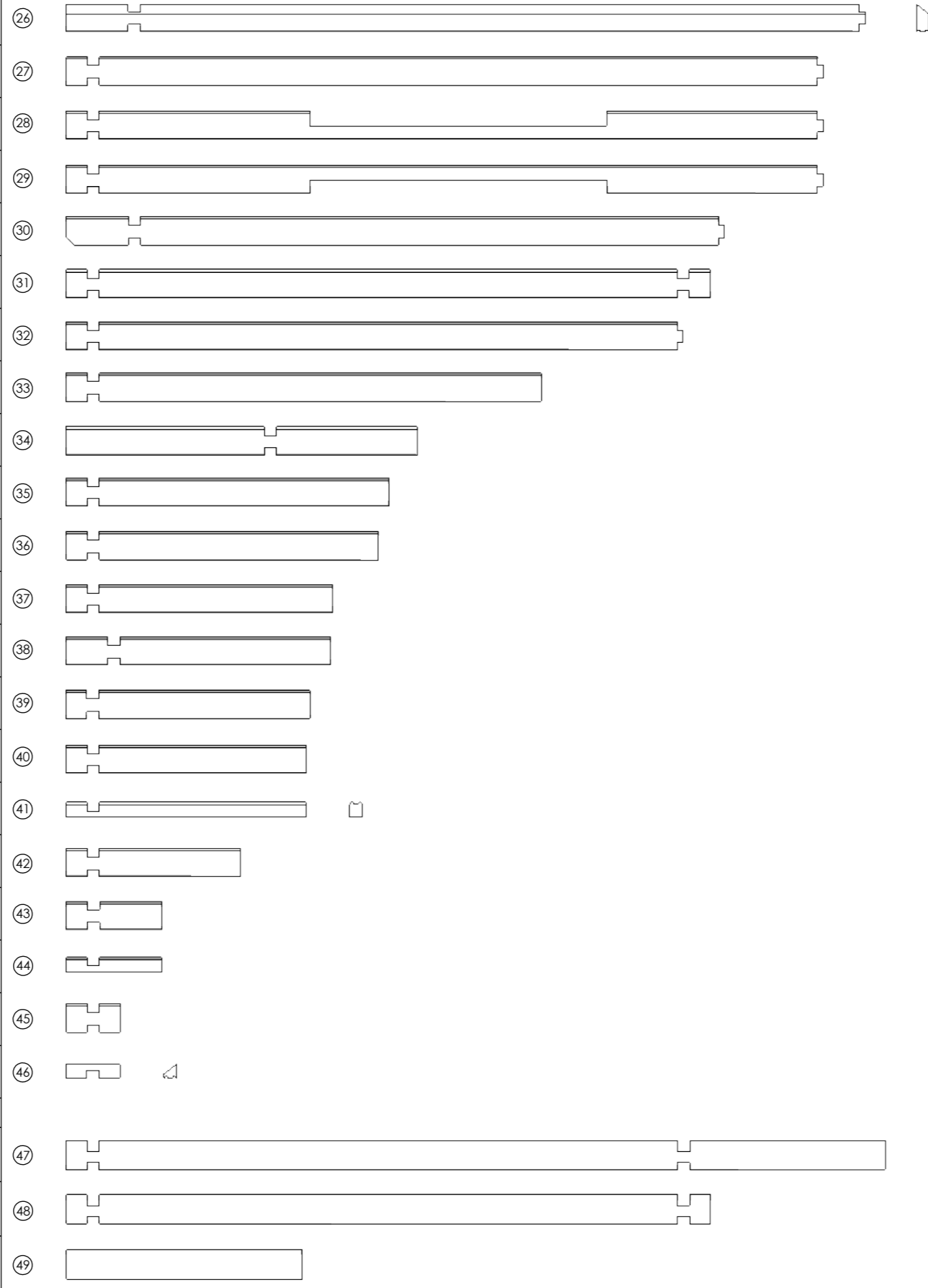

Date	2022-04-07
------	------------

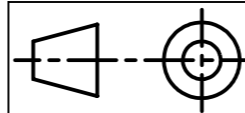

Sheet 4-11

2022-04-07 14:45:17
Date

20186 Amber 50 (60) Pernilla Nilsson [W]

ITEM NO.	QTY.	DESCRIPTION	LENGTH
50	1	RAFTERS 60x200	5580
51	1	RAFTERS 60x200	5580
52	4	RAFTERS 60x200	5580
53	4	RAFTERS 60x200	5580
54	1	RAFTERS 60x200	4000
55	8	RAFTERS 60x200	4000
56	2	RAFTERS 60x280	3380
57	1	RAFTERS 60x140	1825
58	1	SIDE BEAM 130x60	5920
59	1	SIDE BEAM 130x60	5920
60	2	SIDE BEAM 130x60	1510
61	2	SIDE BEAM 130x60	360

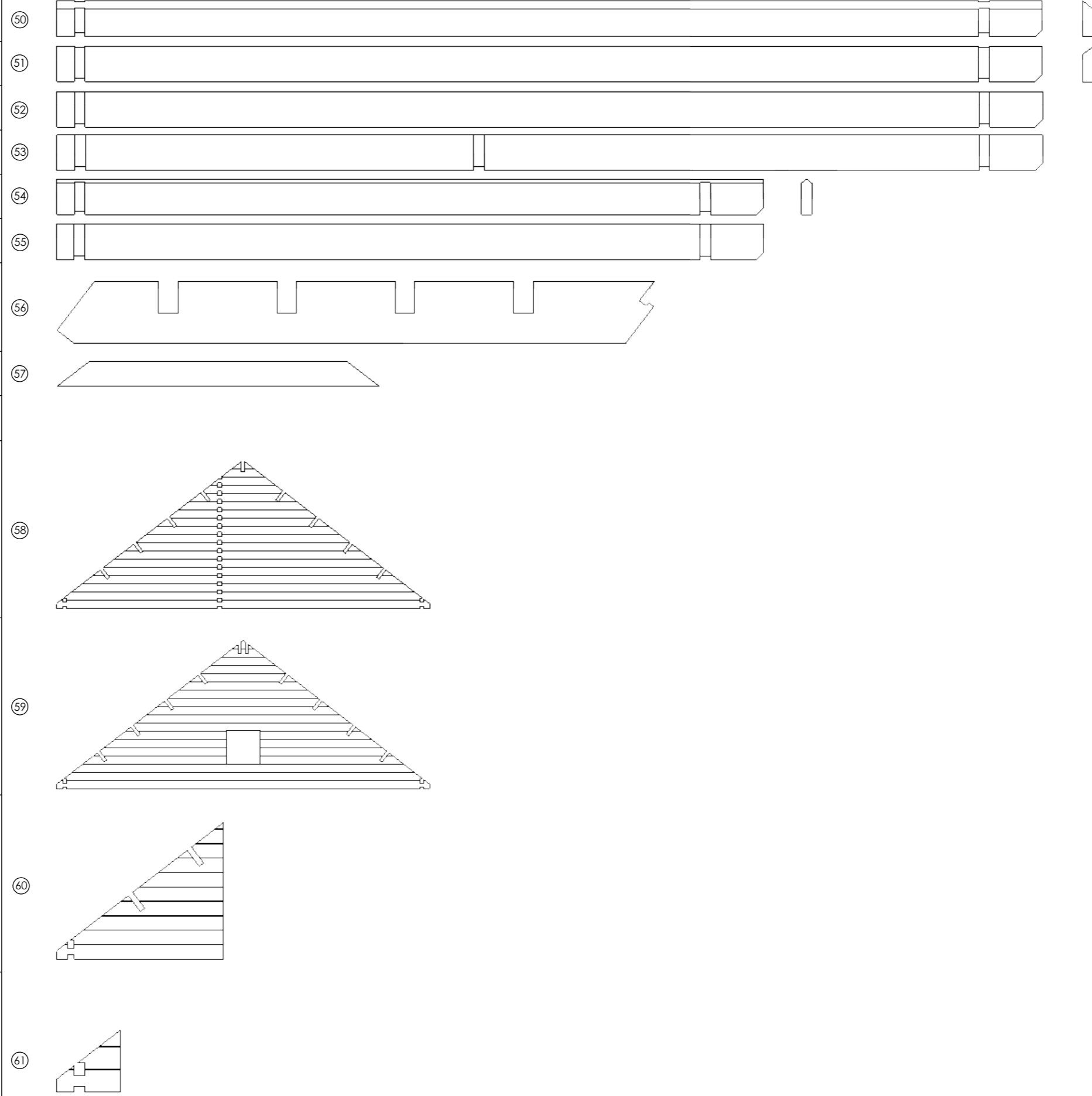

Date	2022-04-07
------	------------

ITEM NO.	QTY.	DESCRIPTION	LENGTH
62	15	FLOOR JOINTS 60X180	5720
63	13	FLOOR JOINTS 60X180	2880
64	86	FLOORBOARD 28x100	5595
65	28	FLOORBOARD 28x100	3135
66	28	FLOORBOARD 28x100	2395
67	11	FLOORBOARD 28x100	1140
68	1	PLINTH 19x50	66 m
69	2	BEAM 28x50	2800
70	4	WINDBOARD 19x100	5760
71	8	WINDBOARD 19x100	4360

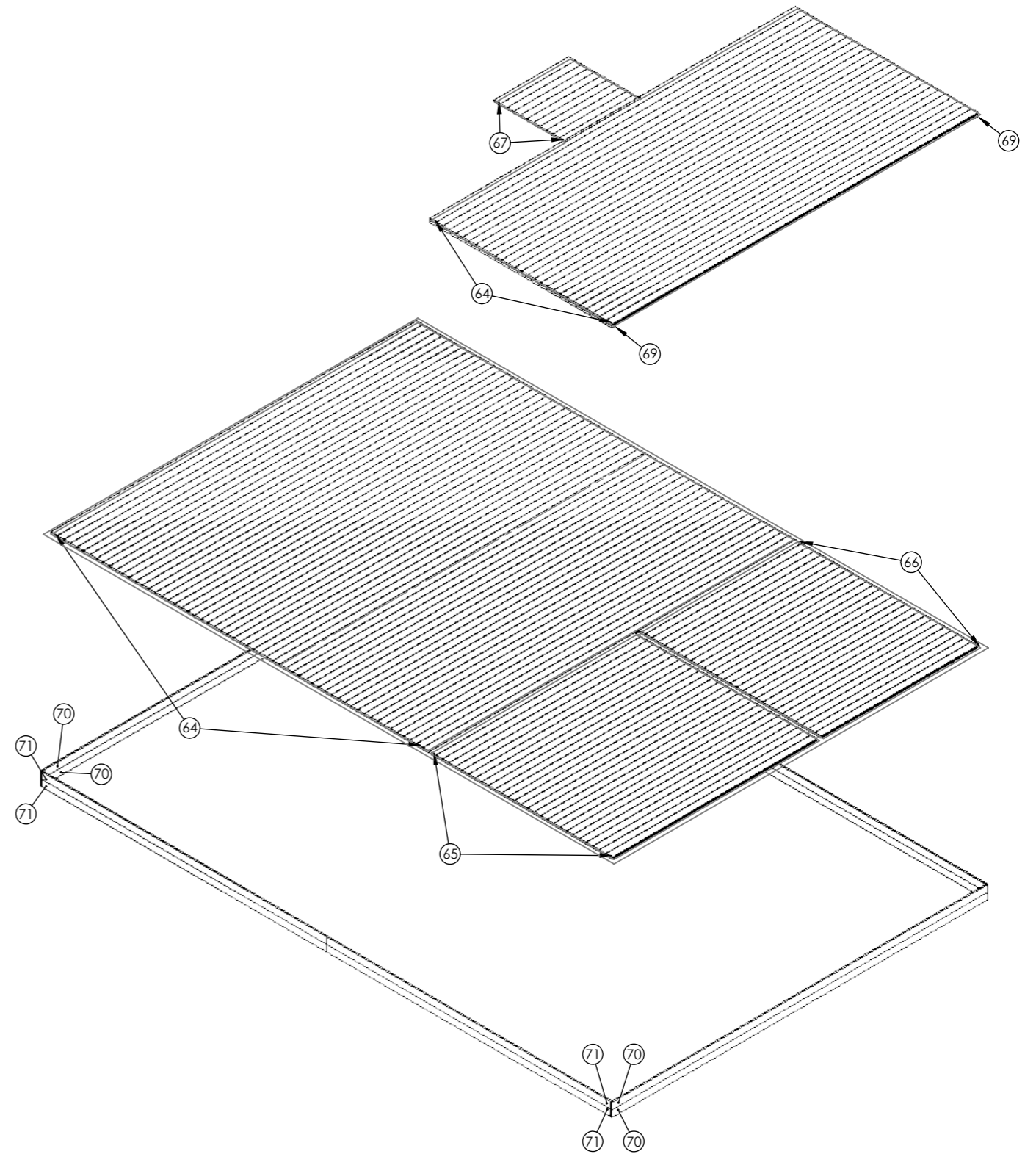
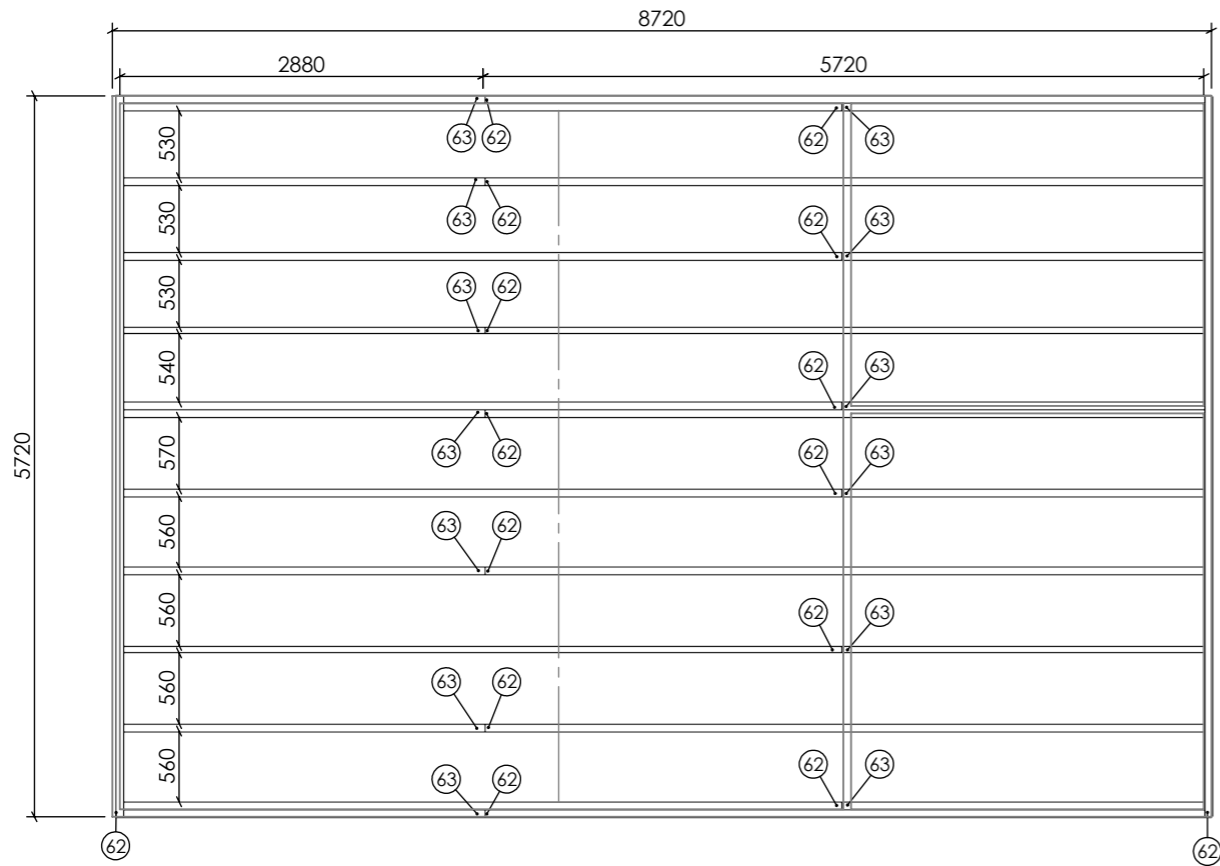

Date	2022-04-07
------	------------

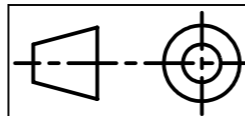

Sheet 1-1

2022-04-07
16:23:43

Date

20186 Amber 50 (60) Pernilla Nilsson [F]

10/18 A3

Pack list 62-71 (4/)

ITEM NO.	QTY.	DESCRIPTION	LENGTH
72	186	ROOF BOARD 19x100	4000
73	4	WINDBOARD 19x100	4660
74	4	WINDBOARD 19x100	4100
75	4	WINDBOARD 19x100	4100
76	4	Windboard 28x50	4660

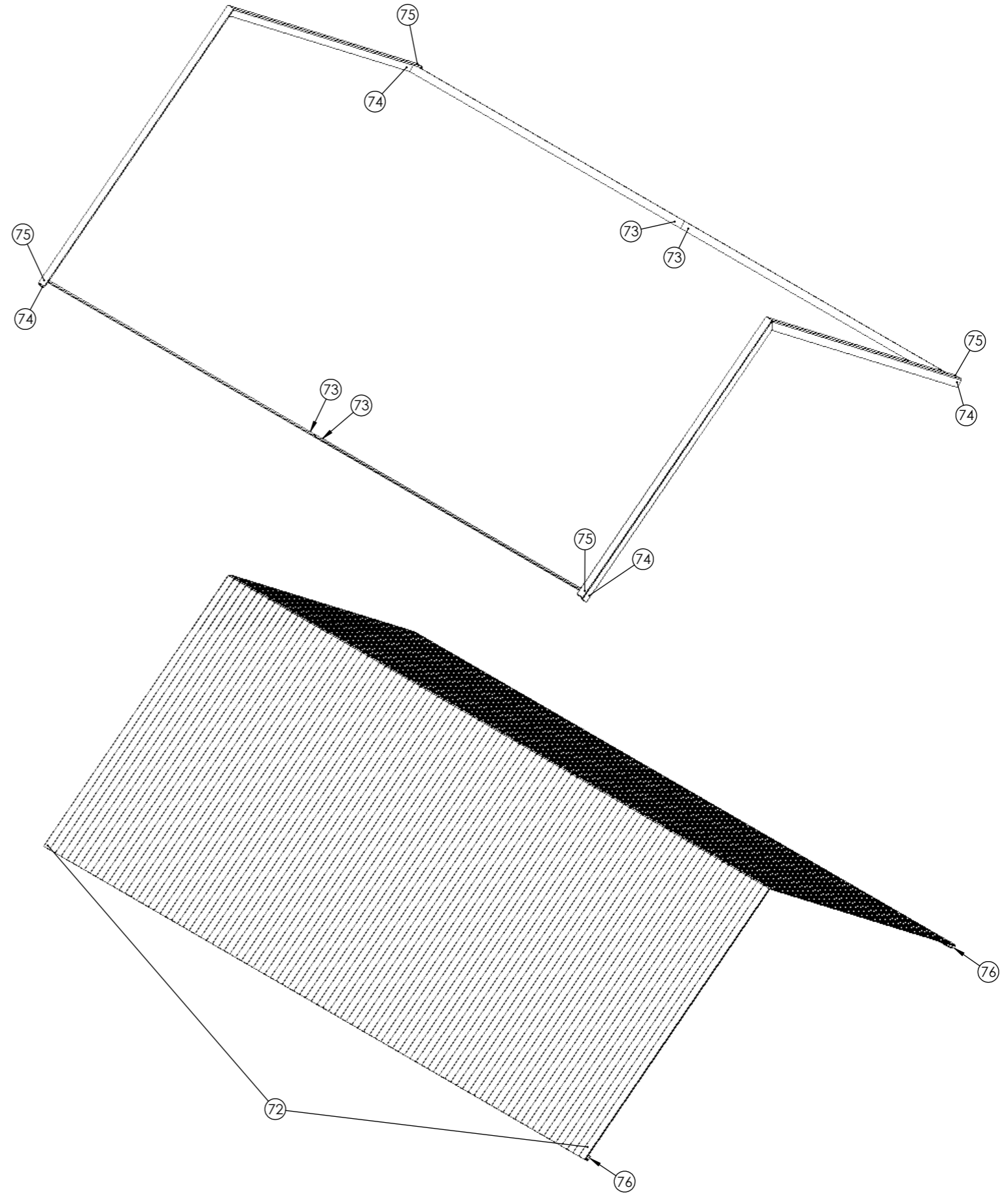

Date	2022-04-07
------	------------

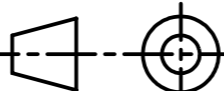
				2022-04-07 16:38:45		20186 Amber 50 (60) Pernilla Nilsson [R]	11/18	A3
	Sheet 1-1	Date					Pack list 72-76 (5/)	

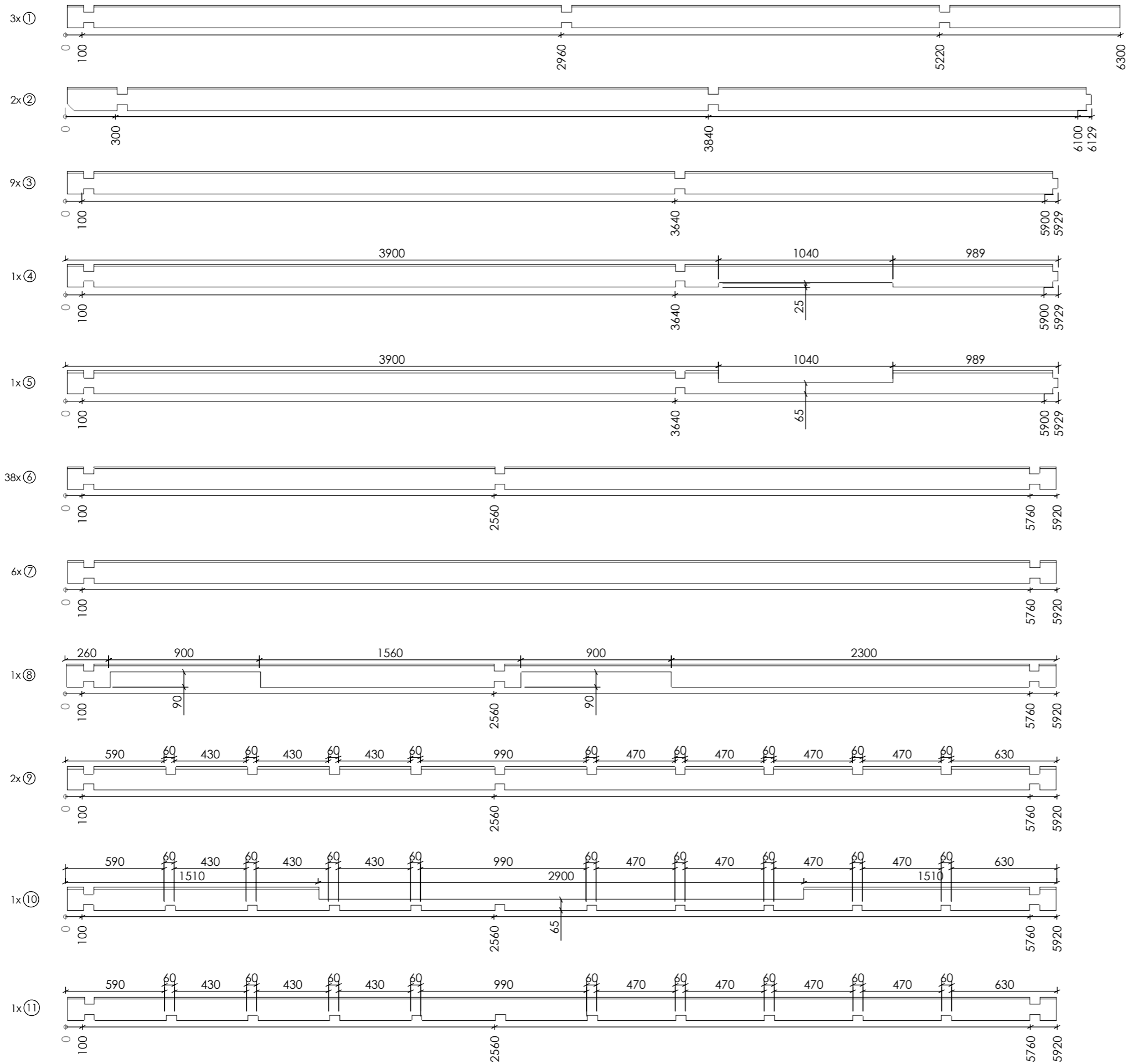

Date	2022-04-07
------	------------

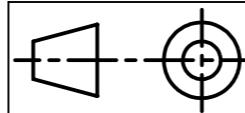

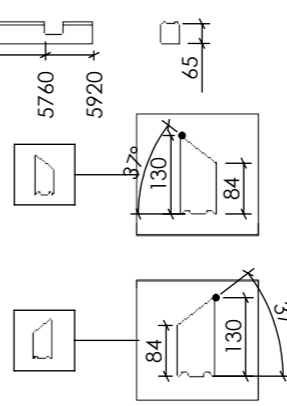
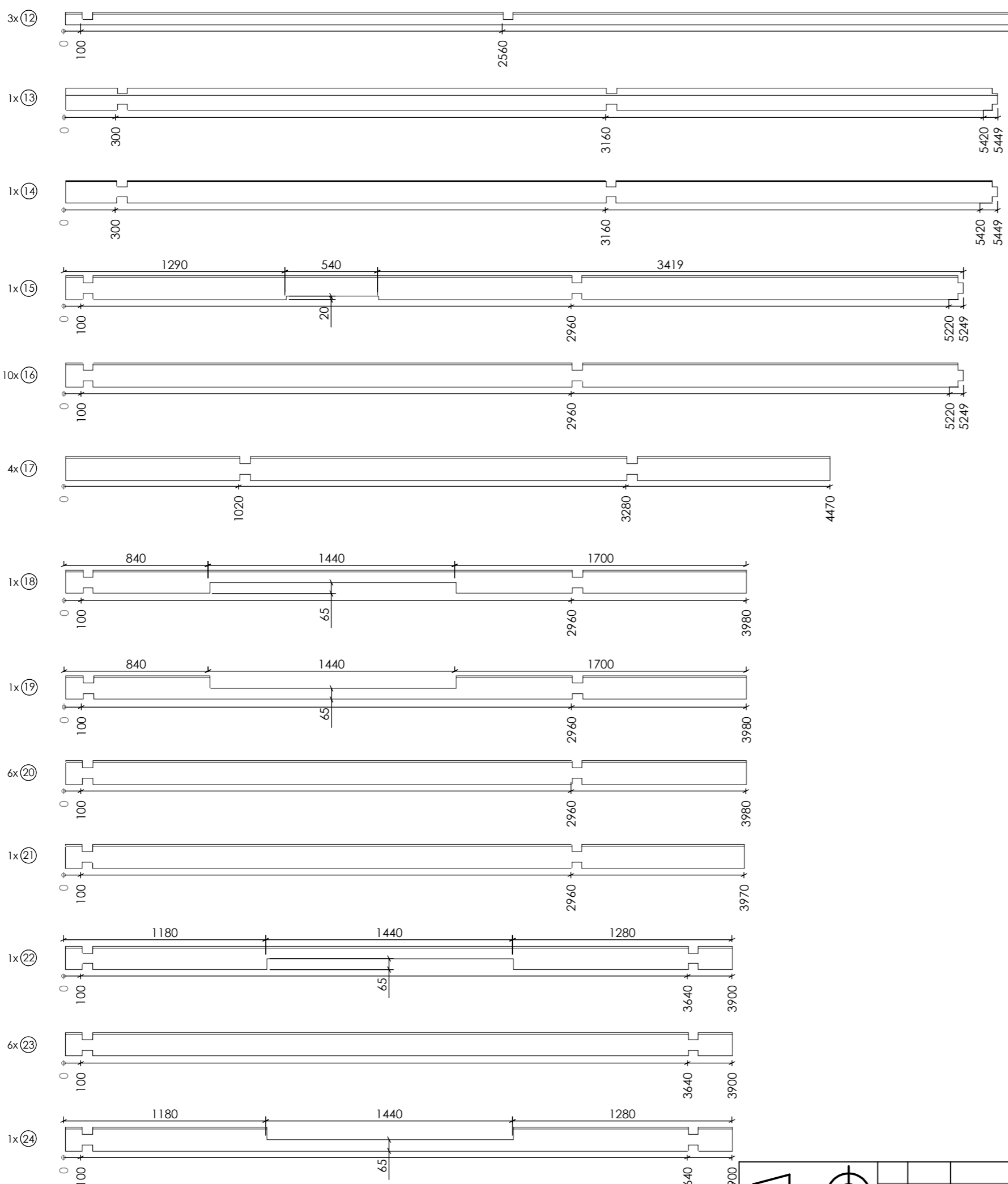

Date	2022-04-07
------	------------

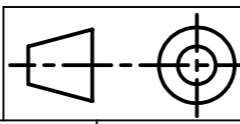

Sheet 7-11

2022-04-07 14:45:17
Date

20186 Amber 50 (60) Pernilla Nilsson [W]

Date	2022-04-07
------	------------

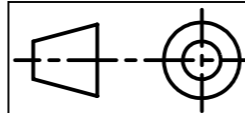
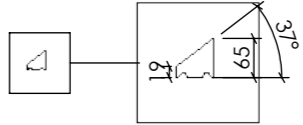
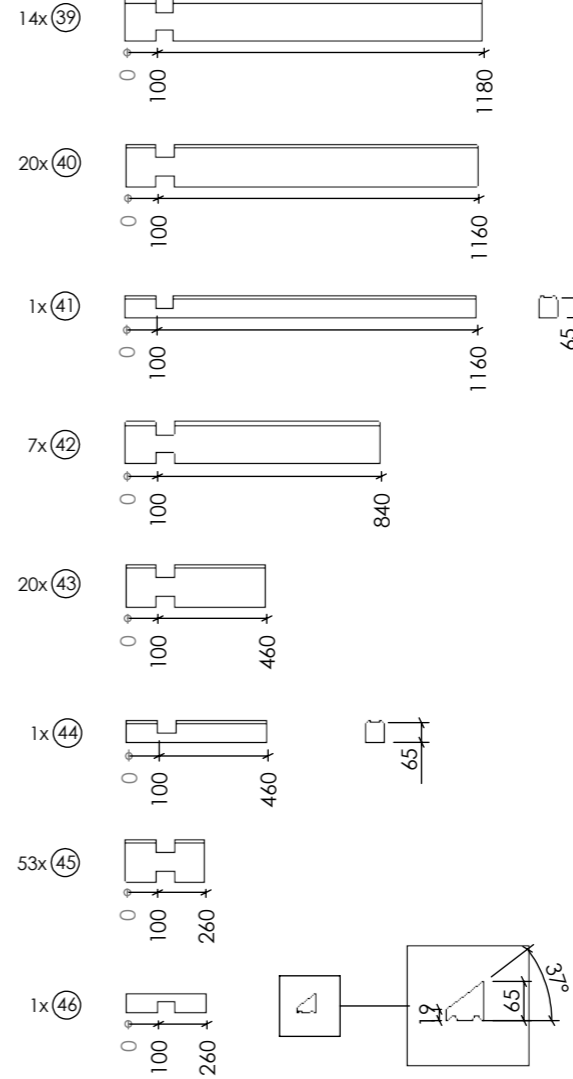
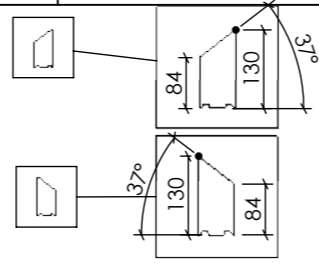
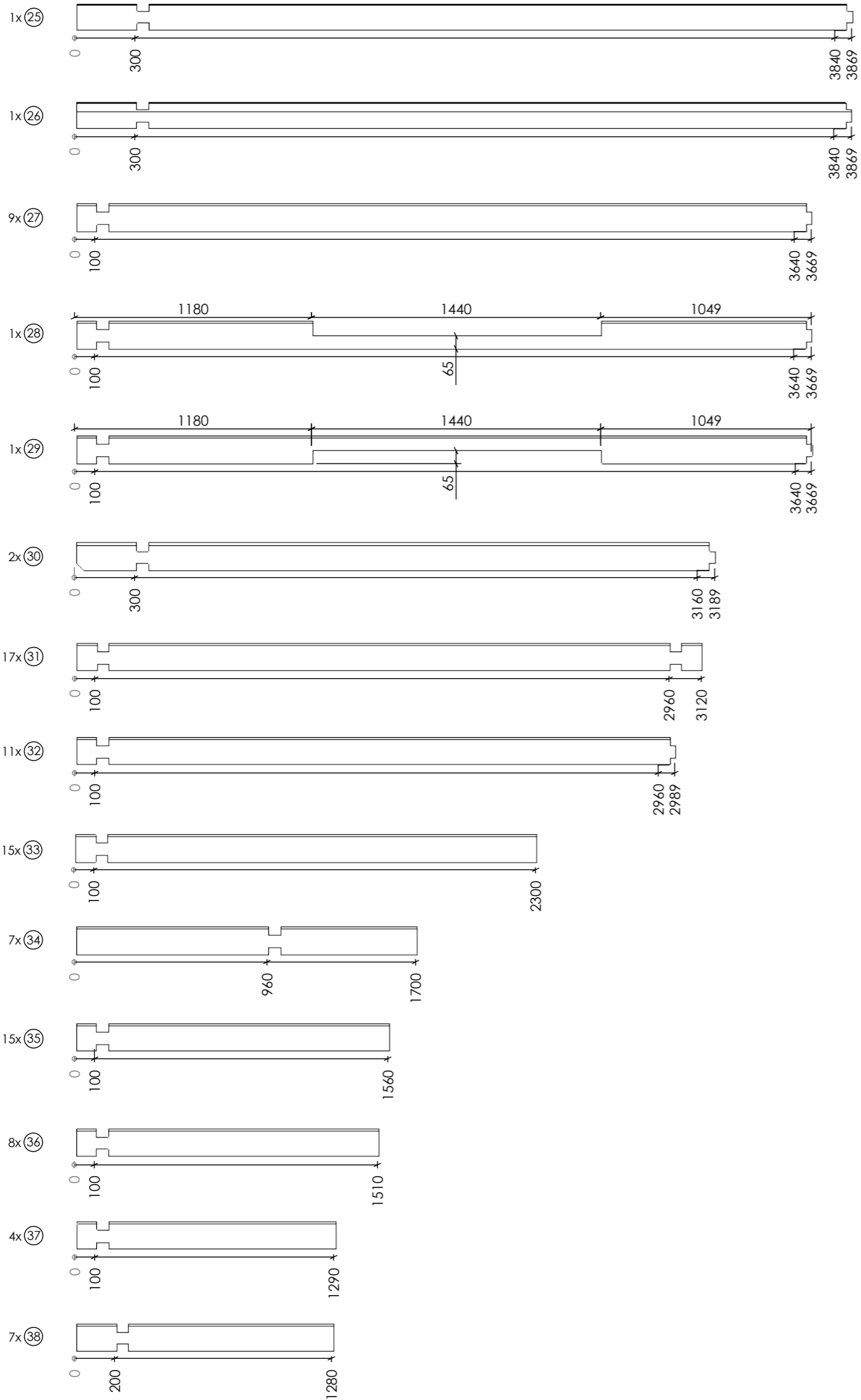

Floor beams 60x140

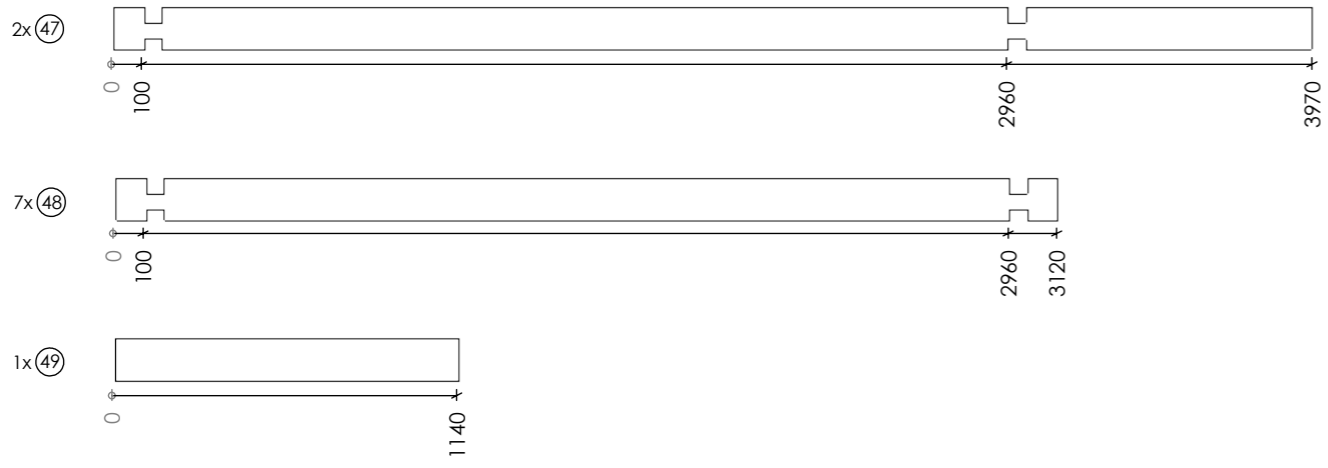

Roof rafters 60x200

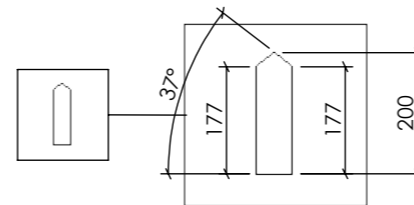
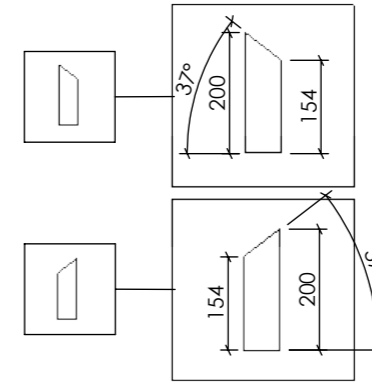
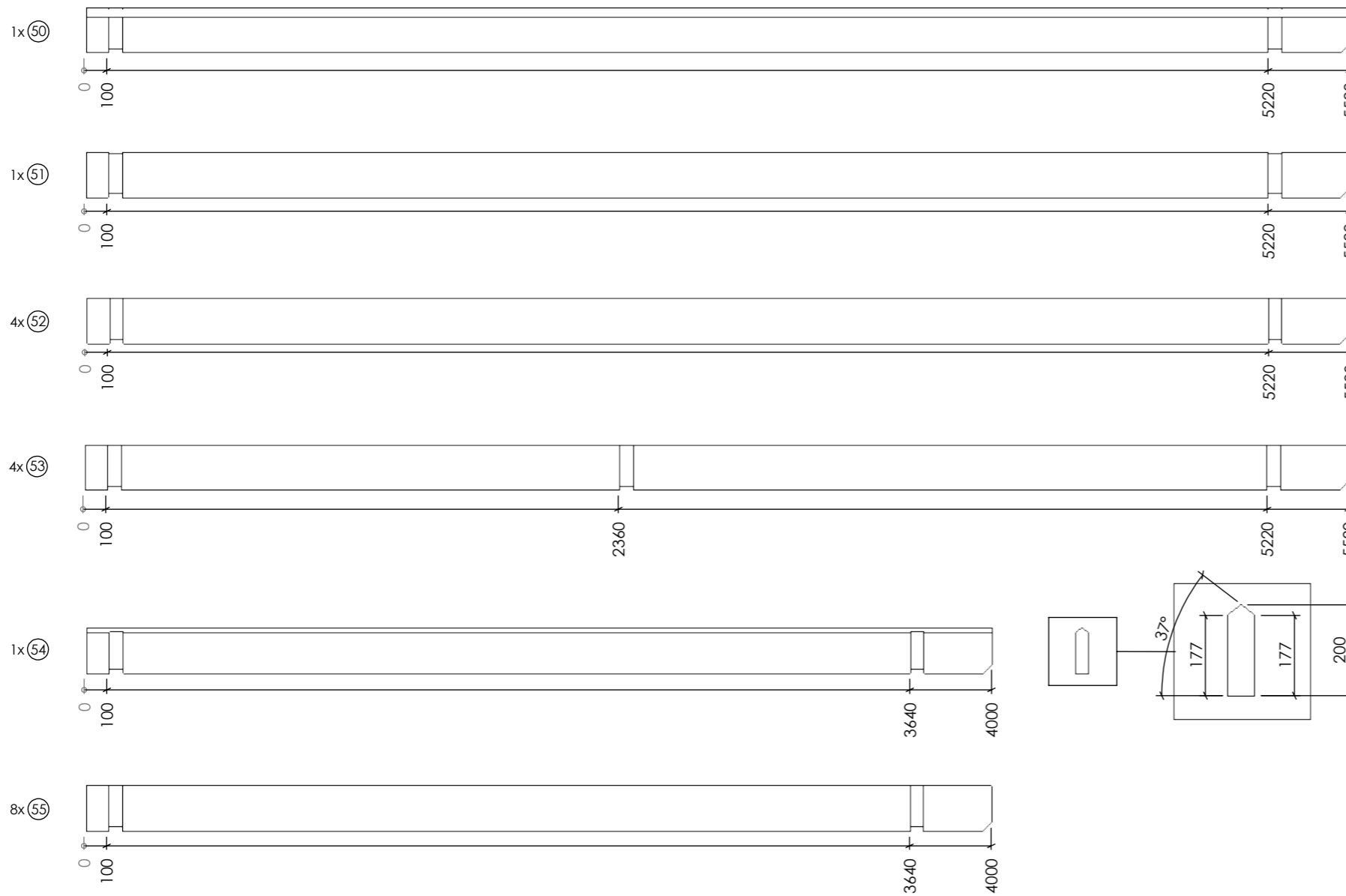

Date	2022-04-07
------	------------

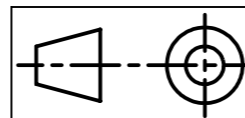

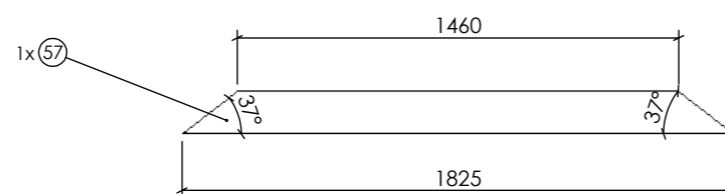
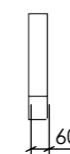
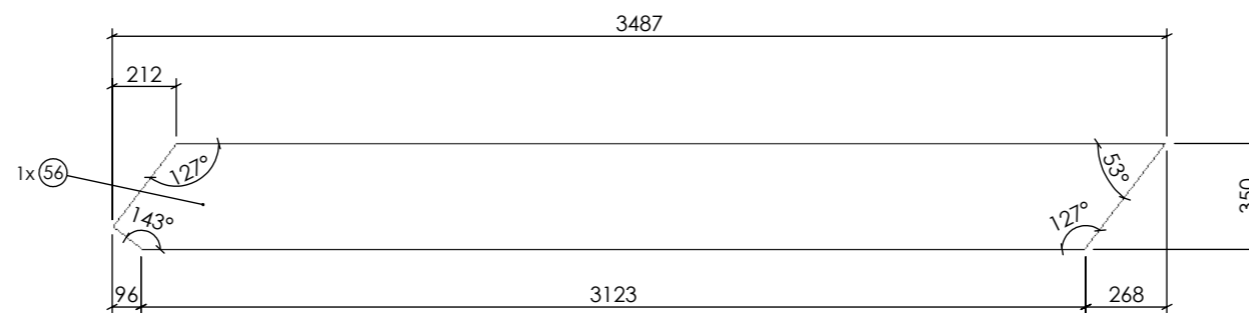
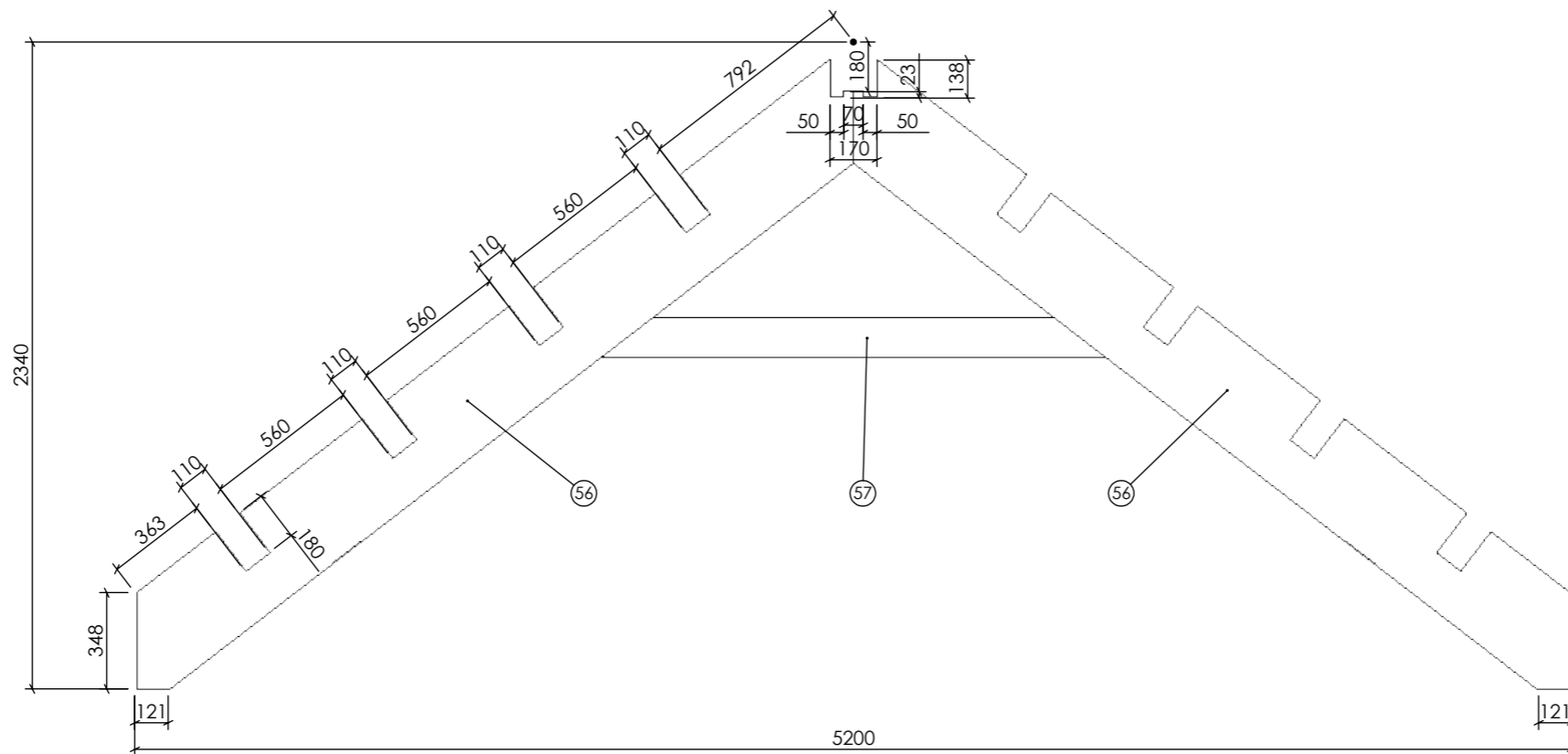

Date	2022-04-07
------	------------

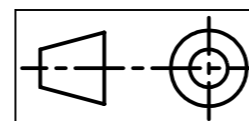

Sheet 10-11

2022-04-07
14:45:17

Date

20186 Amber 50 (60) Pernilla Nilsson [W]

16/18 A3

56-57

1x (58)

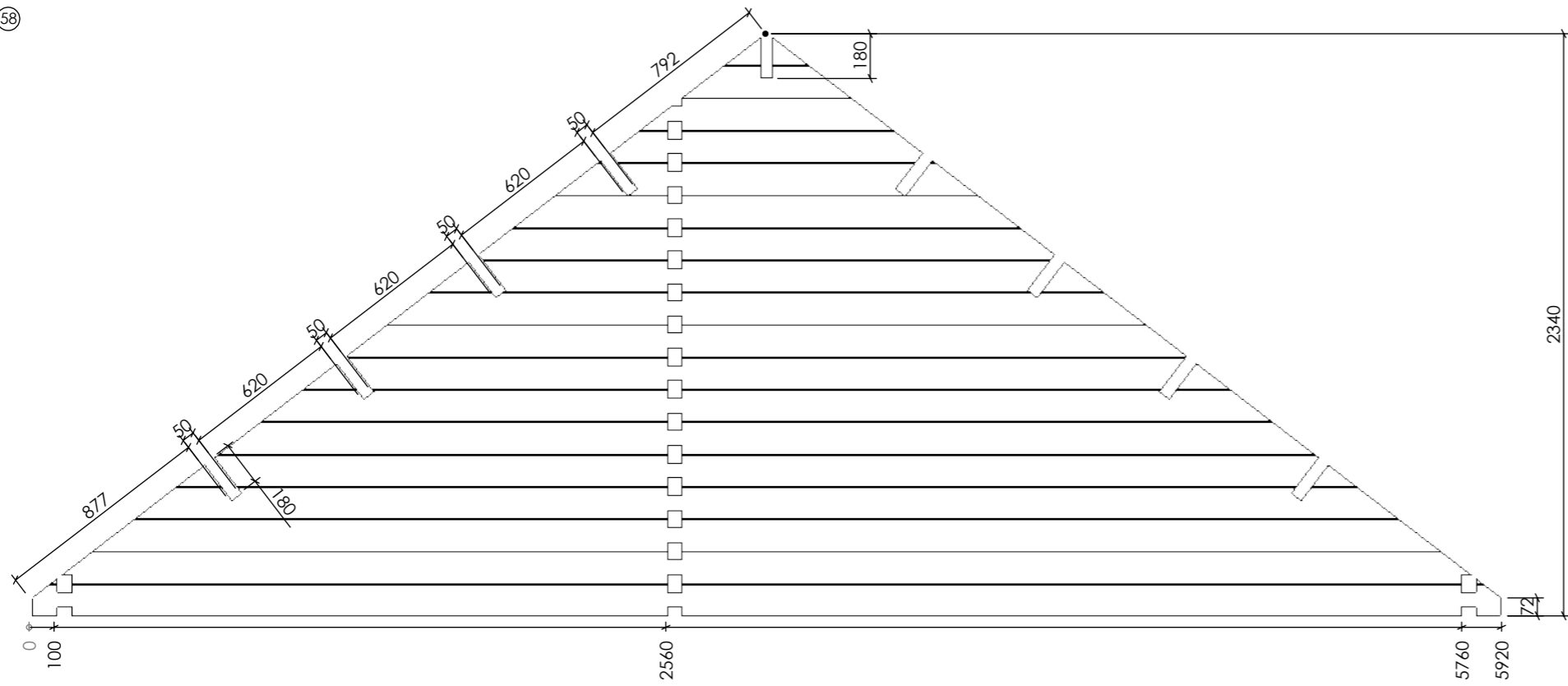

2x (60)

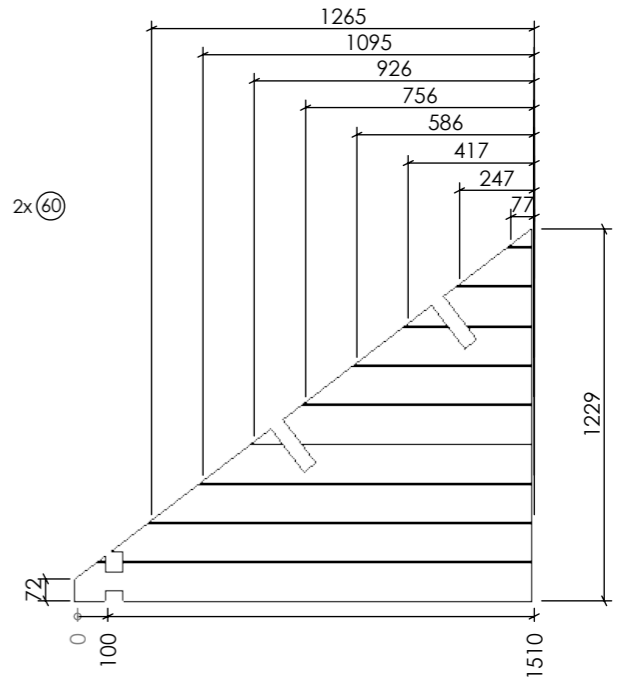

1x (59)

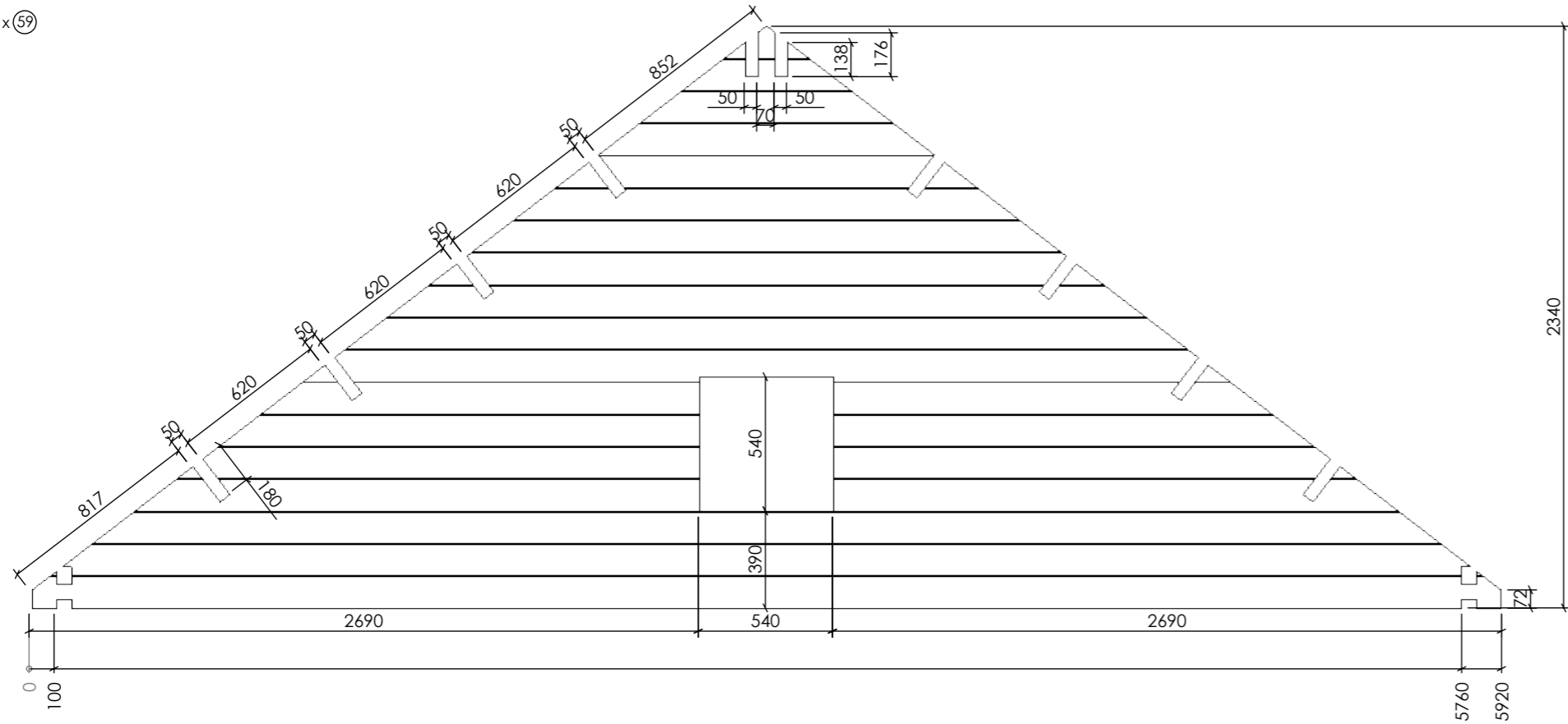

2x (61)

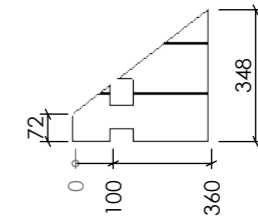

Date	2022-04-07
------	------------

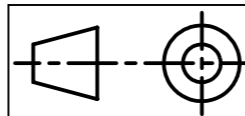

Sheet 11-11

2022-04-07
14:45:17

Date

20186 Amber 50 (60) Pernilla Nilsson [W]

17/18 A3

58-61

Date	2022-04-07
------	------------

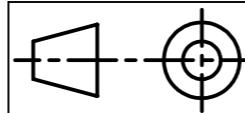
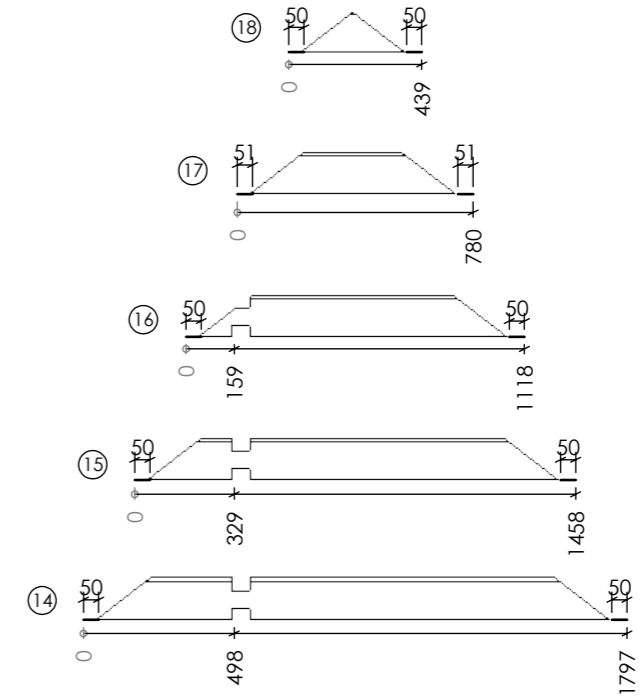
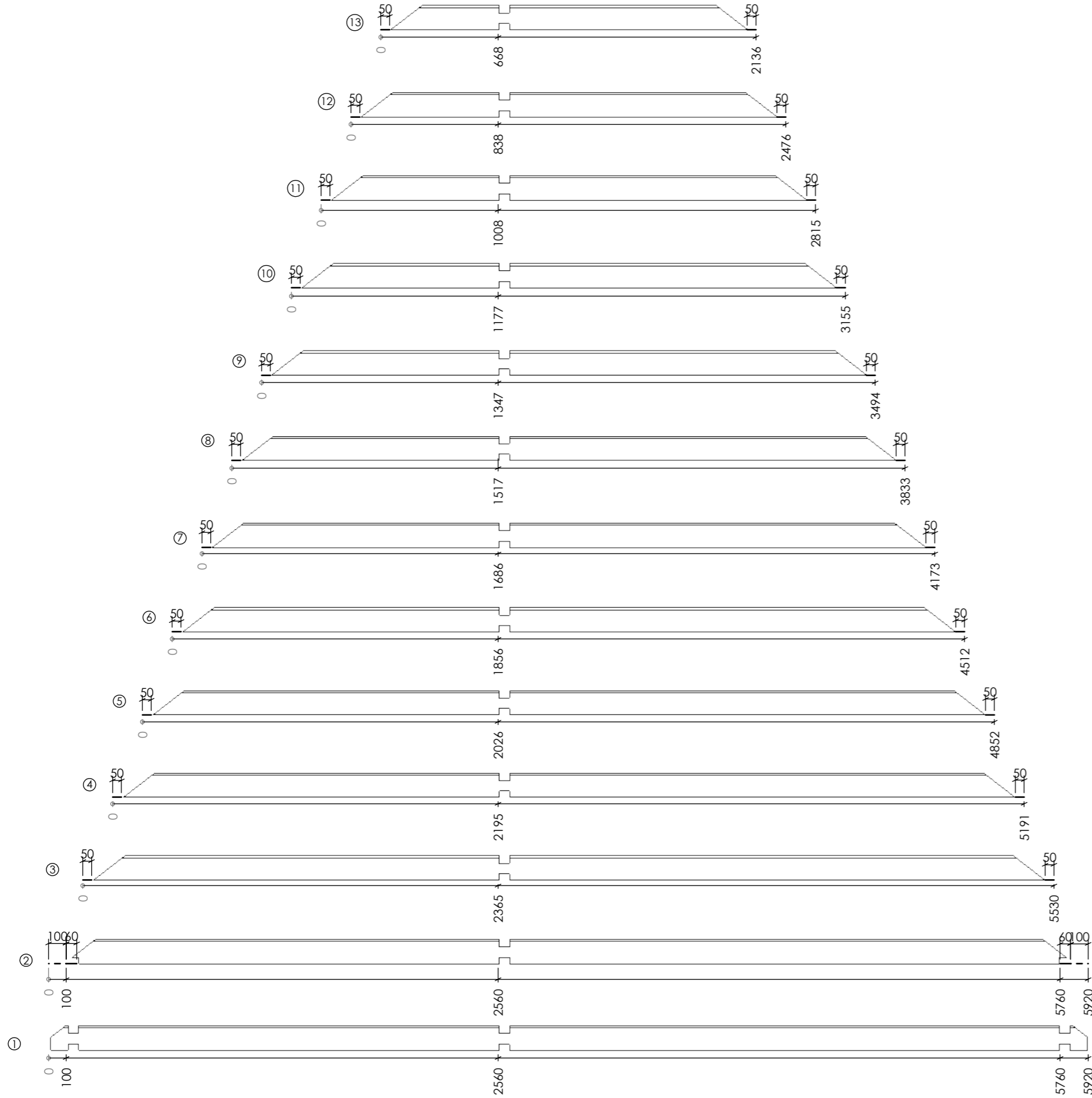

Sheet 1-1

2022-04-07
15:35:23

Date

20186 Amber 50 (60) Pernilla Nilsson [Kraigai]

18/18 A3

Kraigas 58