

Date	2022-07-20
	10:16:53

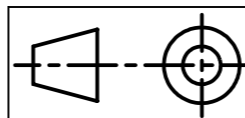

G	Sheet 2-2	2022-07-20 10:16:53	20273 Marten 30 (44)	1/14	A3
		Date		3D (1/2)	

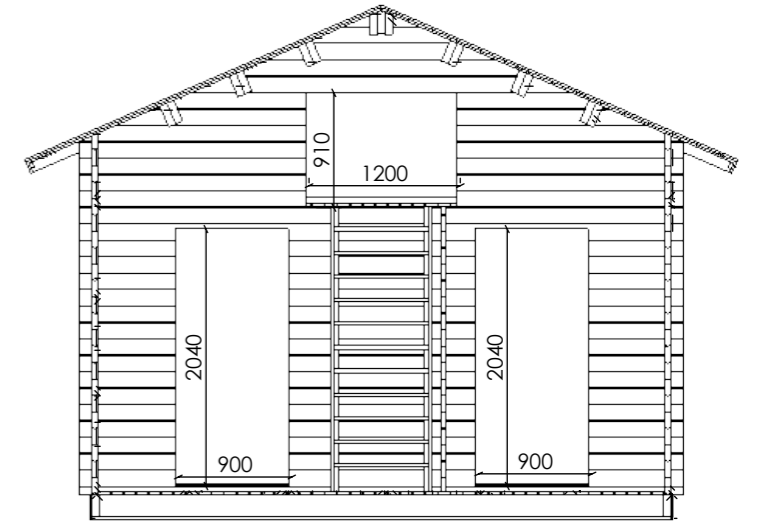
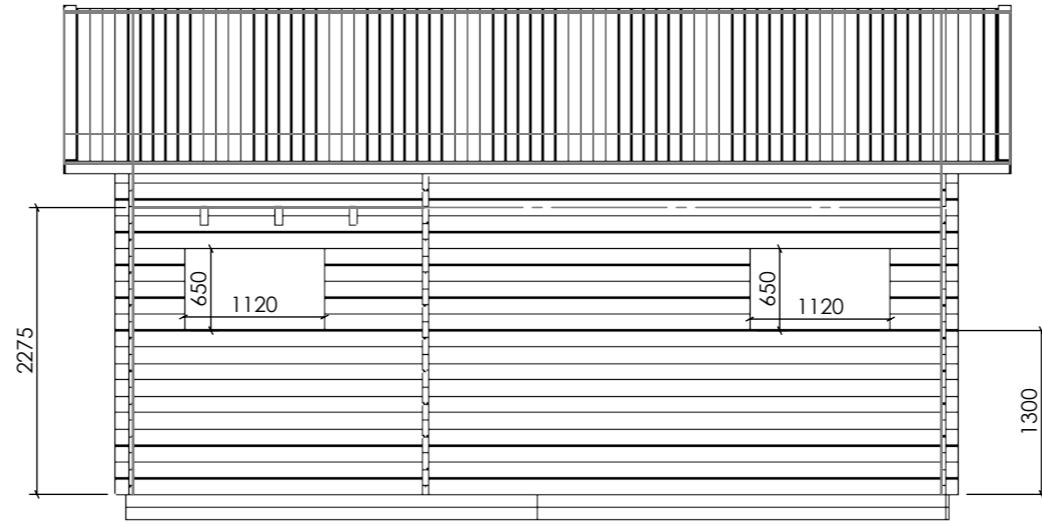
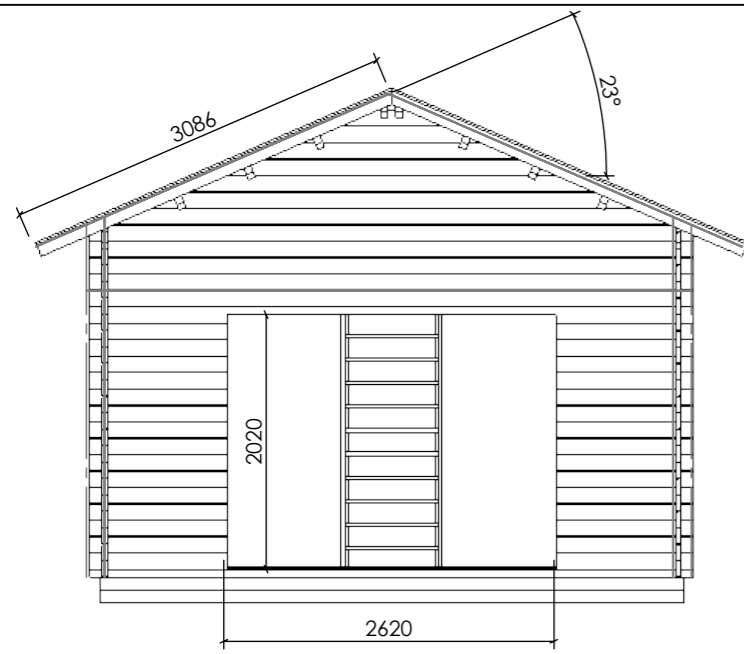

Indoor wall

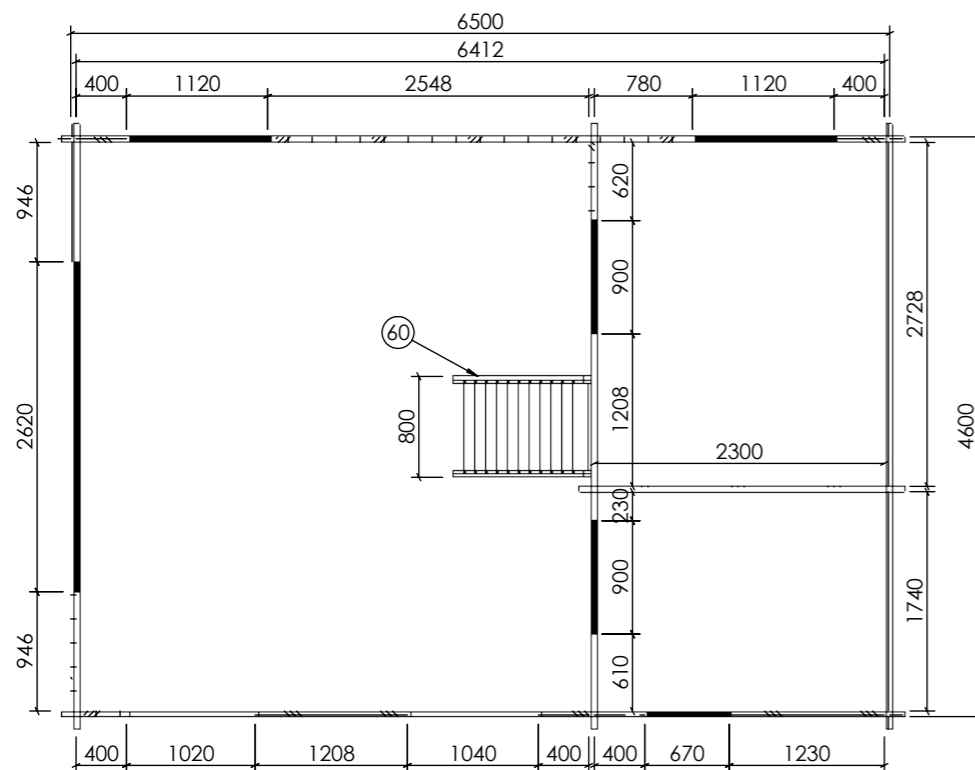
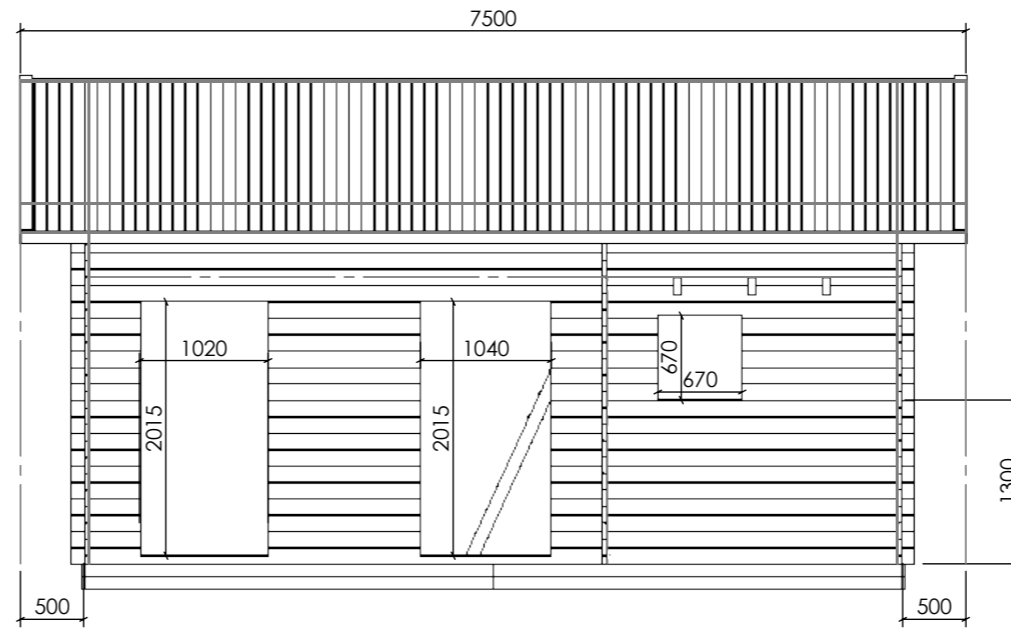
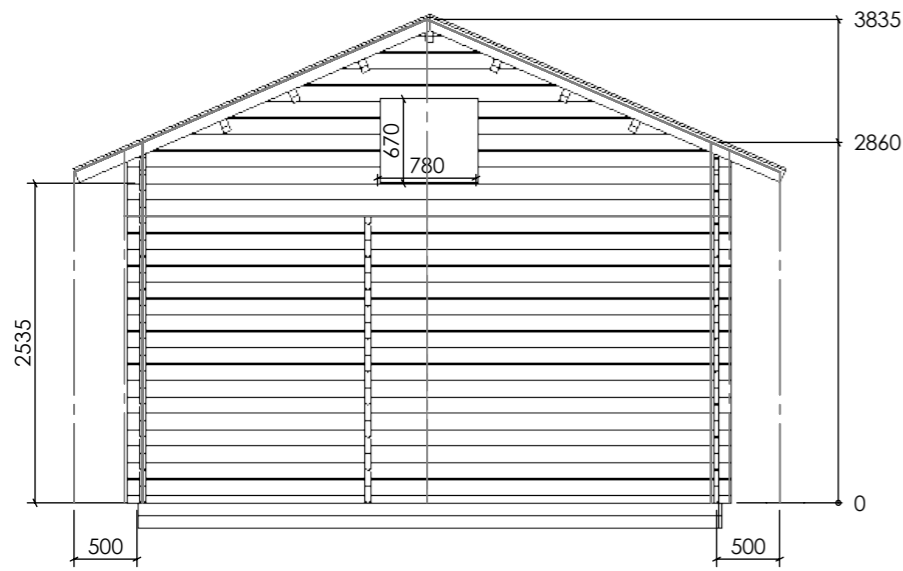

Floor Plan

POS. NO.	ELEMENT	QTY.
60	Echelle	1

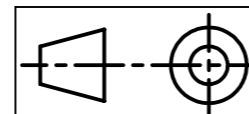

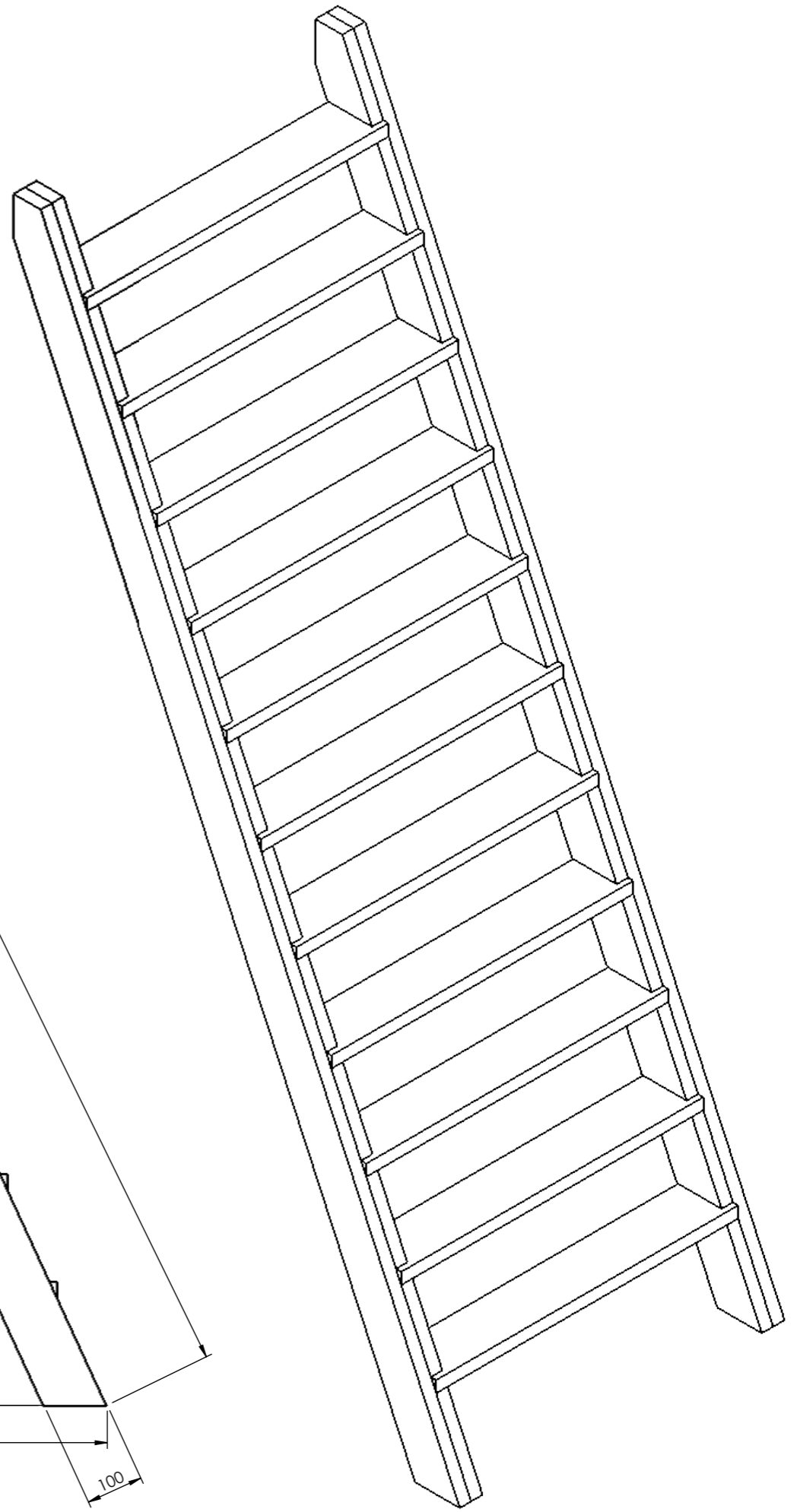
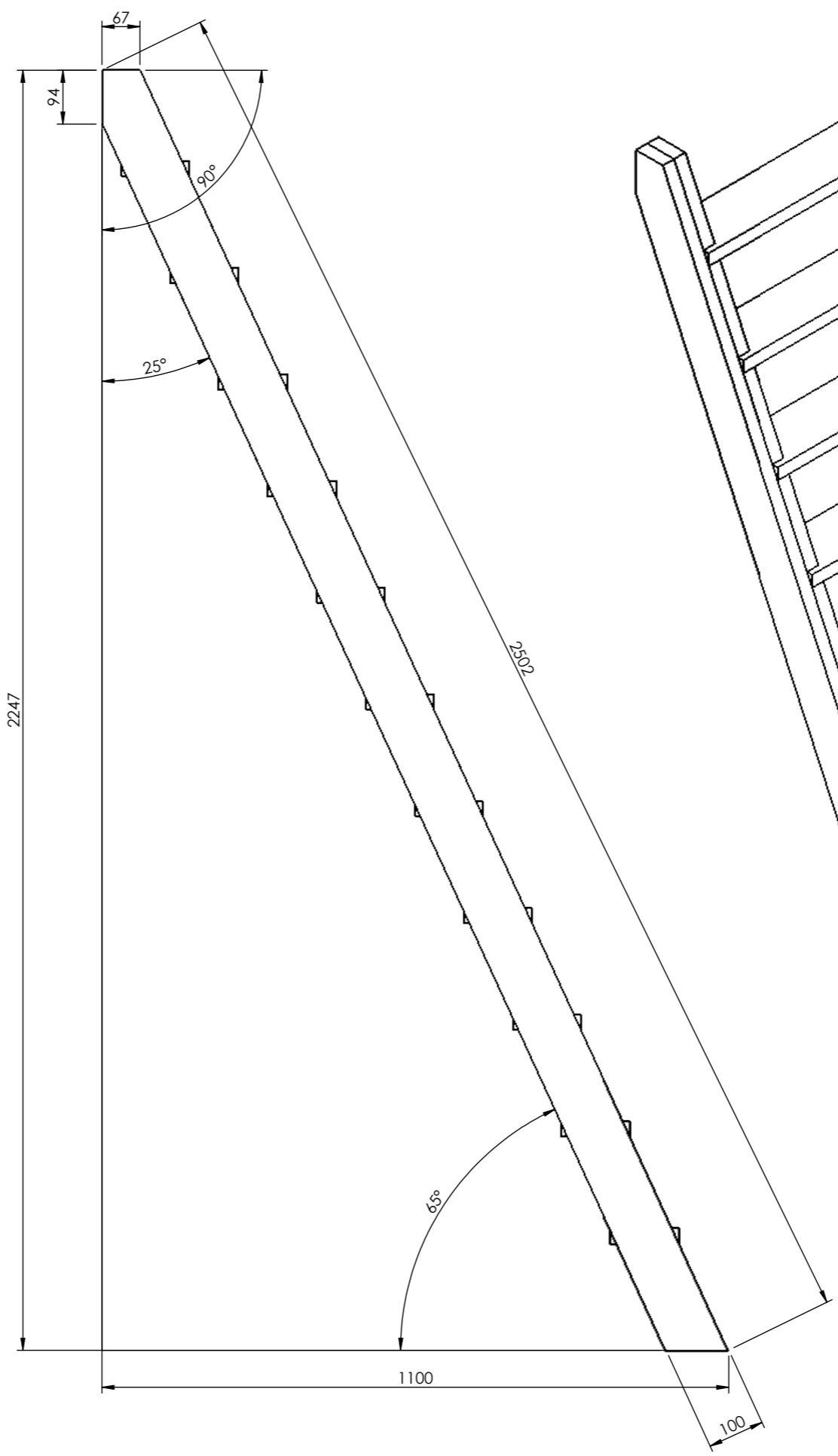
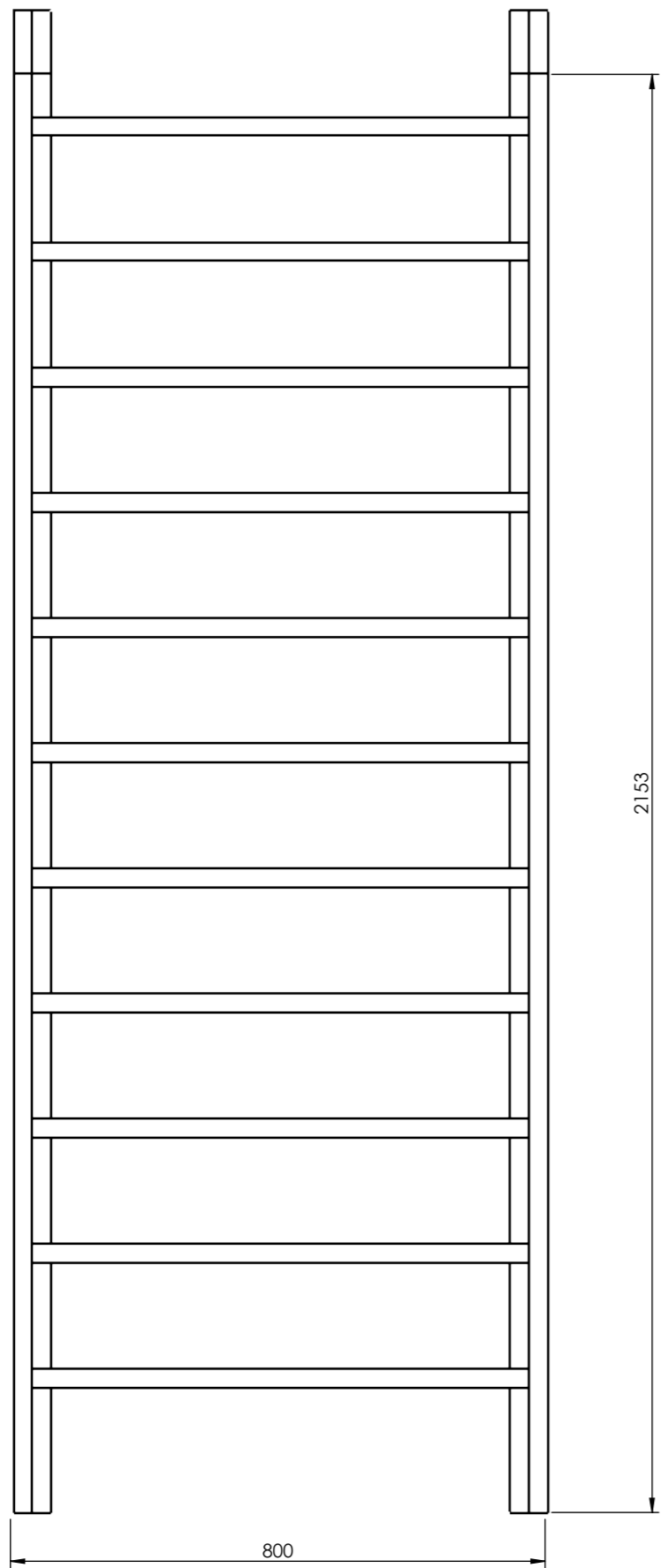

Date	2022-07-26
16:26:42	

		G	Sheet 1-1	2022-07-26	16:26:42	Escalier3	3/14	A3
				Date			Sheet1	

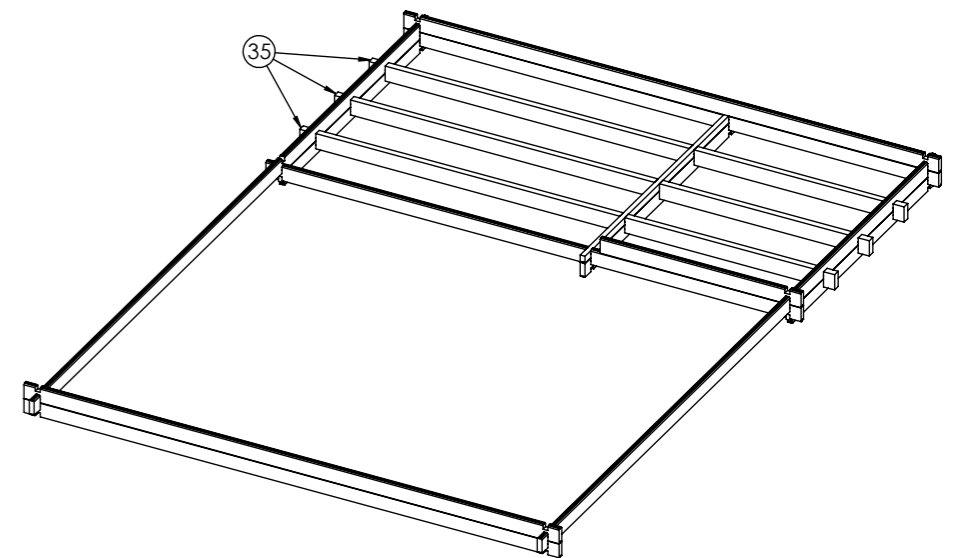
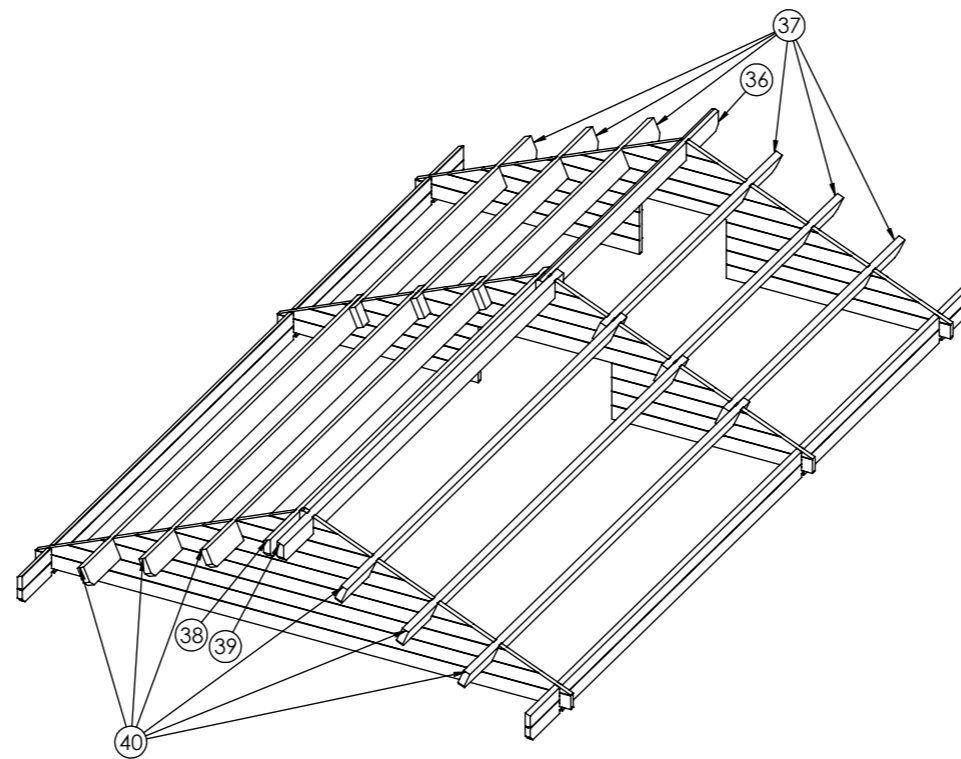
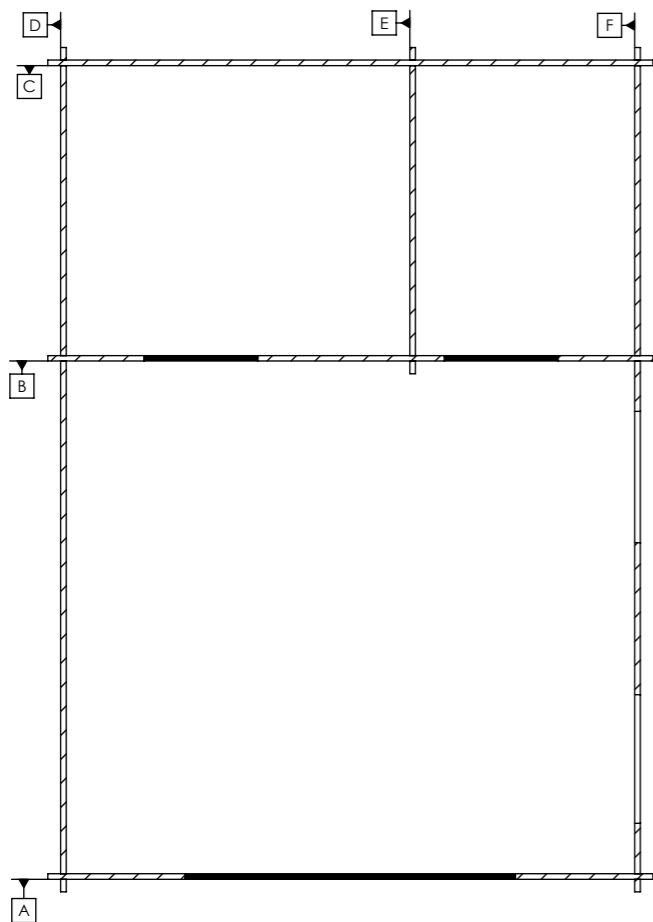
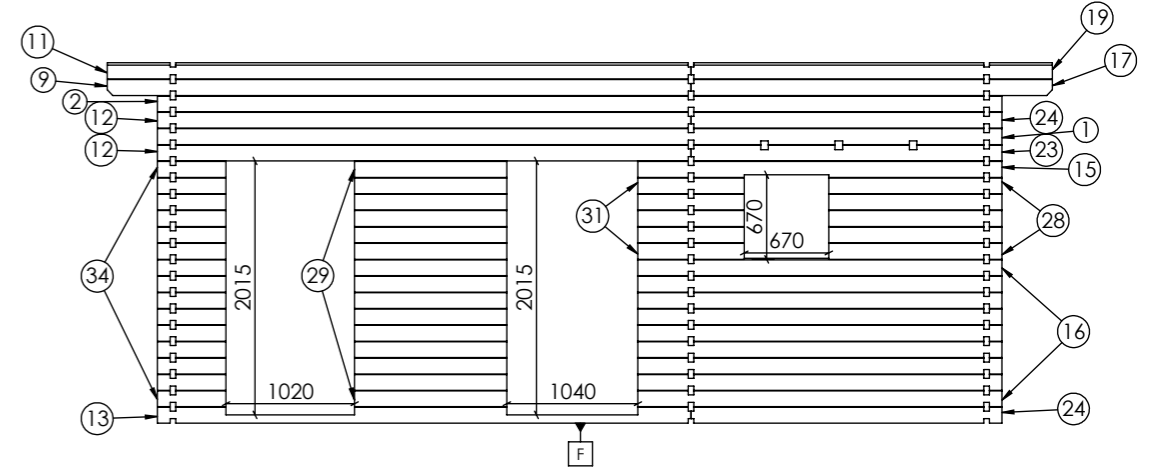
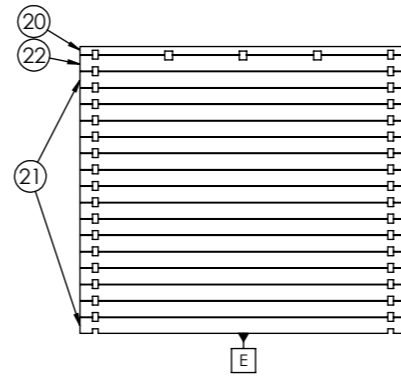
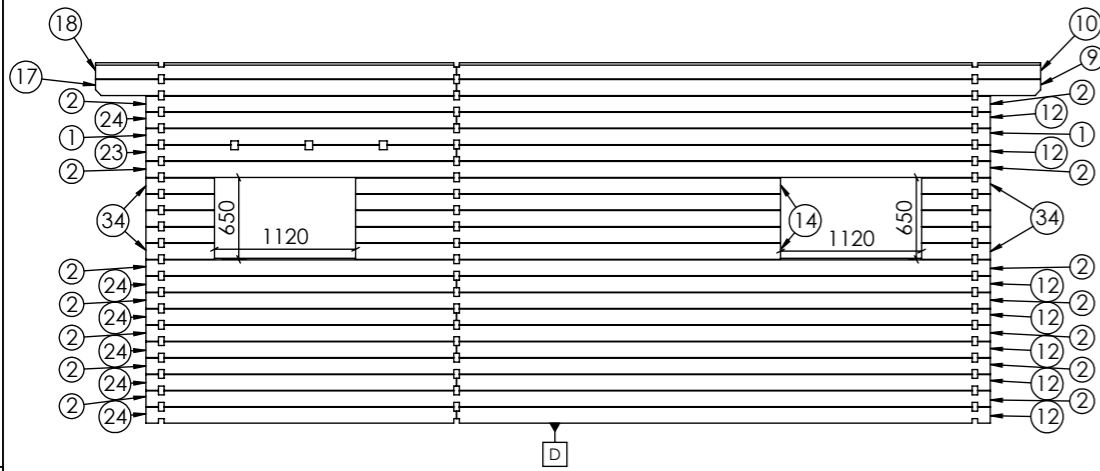
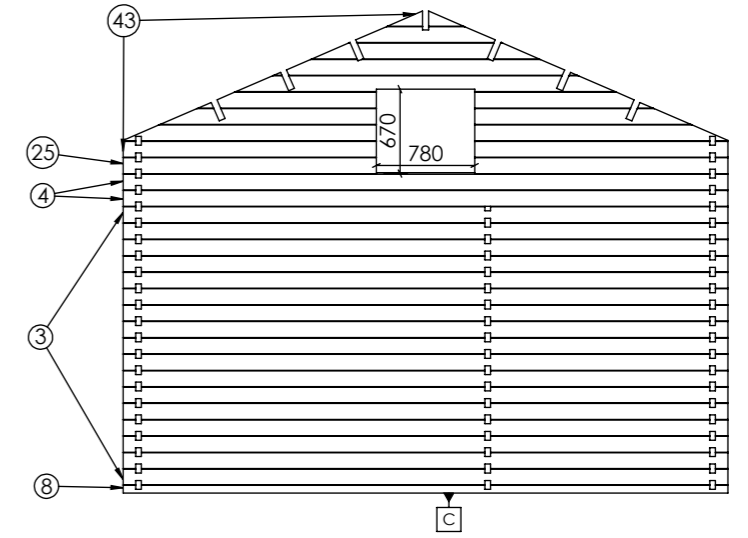
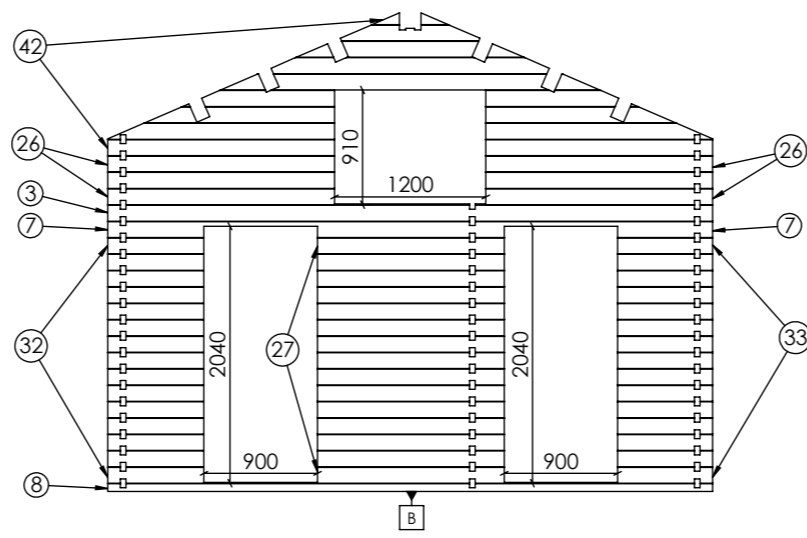
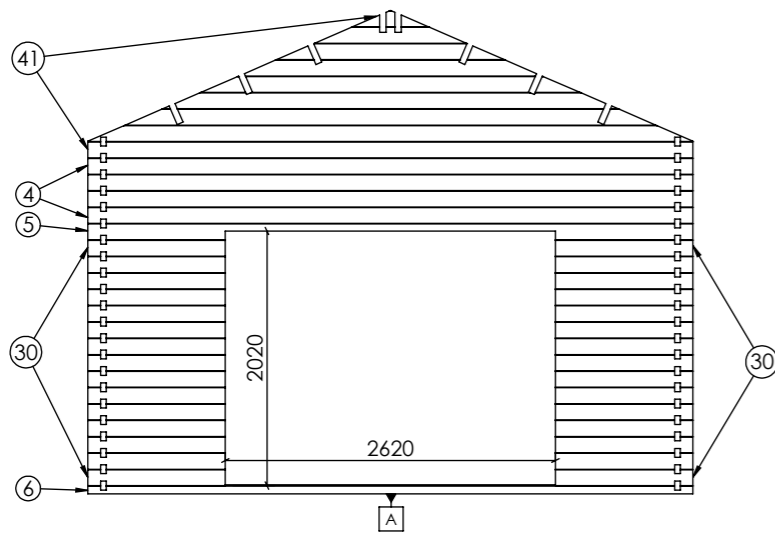

Date  
2022-07-27  
08:48:24

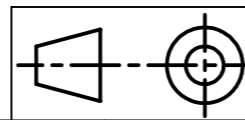

G	Sheet 1-9	Date	2022-07-27 08:48:24	20273 Marten 30 (44)(W) Kaj. P	4/14 A3
					A;B;C;D;E;F

POS. NO.	QTY.	Description	Longueur
1	2	SIDE BEAM 130x44	6700
2	8	SIDE BEAM 130x44	6700
3	18	SIDE BEAM 130x44	4800
4	6	SIDE BEAM 130x44	4800
5	1	SIDE BEAM 130x44	4800
6	1	SIDE BEAM 130x44	4800
7	1	SIDE BEAM 130x44	4800
8	2	SIDE BEAM 130x44	4800
9	2	SIDE BEAM 130x44	4634
10	1	SIDE BEAM 130x44	4634
11	1	SIDE BEAM 130x44	4634
12	9	SIDE BEAM 130x44	4234
13	1	SIDE BEAM 130x44	4234
14	5	SIDE BEAM 130x44	3372
15	1	SIDE BEAM 130x44	2888
16	9	SIDE BEAM 130x44	2888
17	2	SIDE BEAM 130x44	2866
18	1	SIDE BEAM 130x44	2866
19	1	SIDE BEAM 130x44	2866
20	1	SIDE BEAM 130x44	2588
21	16	SIDE BEAM 130x44	2588
22	1	SIDE BEAM 130x44	2588
23	2	SIDE BEAM 130x44	2466
24	8	SIDE BEAM 130x44	2466
25	2	SIDE BEAM 130x44	2010



Date  
2022-07-27  
08:48:24

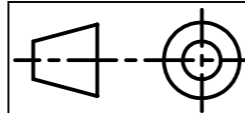

POS. NO.	QTY.	Description	Longueur
26	6	SIDE BEAM 130x44	1800
27	15	SIDE BEAM 130x44	1482
28	5	SIDE BEAM 130x44	1374
29	15	SIDE BEAM 130x44	1208
30	30	SIDE BEAM 130x44	1090
31	5	SIDE BEAM 130x44	844
32	15	SIDE BEAM 130x44	764
33	15	SIDE BEAM 130x44	754
34	25	SIDE BEAM 130x44	544
35	3	FLOOR BALKS 140x60	4800
36	1	RAFTERS 60x180	2988
37	6	RAFTERS 60x180	2988
38	1	RAFTERS 60x180	4756
39	1	RAFTERS 60x180	4756
40	6	RAFTERS 60x180	4756

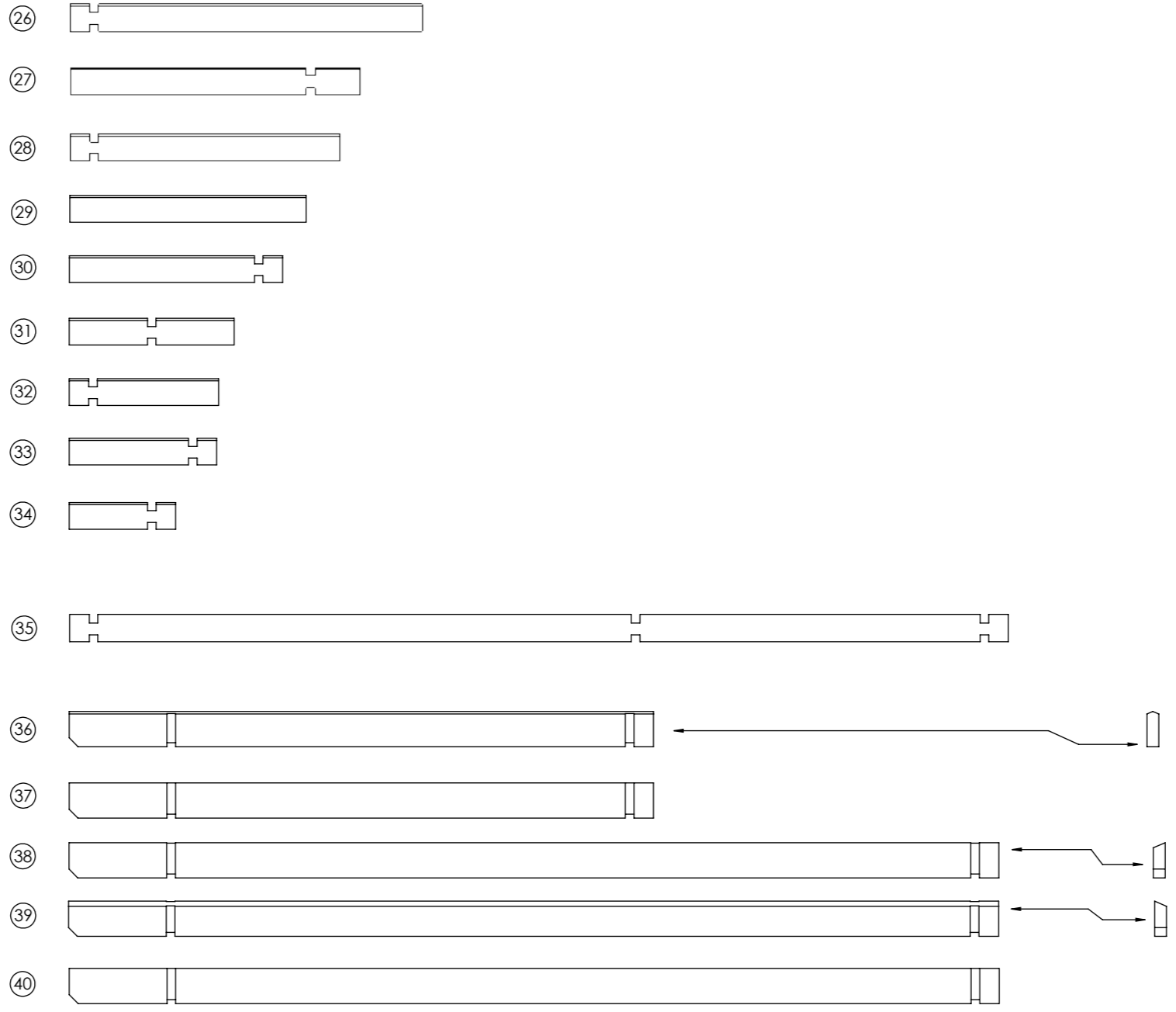

Date	2022-07-27 08:48:24
------	------------------------

POS. NO.	QTY.	Description	Longueur
41	1	SIDE BEAM 130x44	4800
42	1	SIDE BEAM 130x44	4800
43	1	SIDE BEAM 130x44	4800

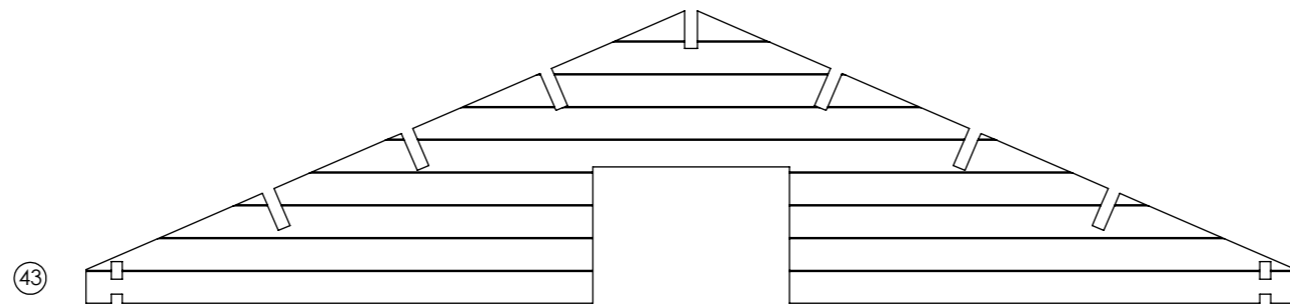
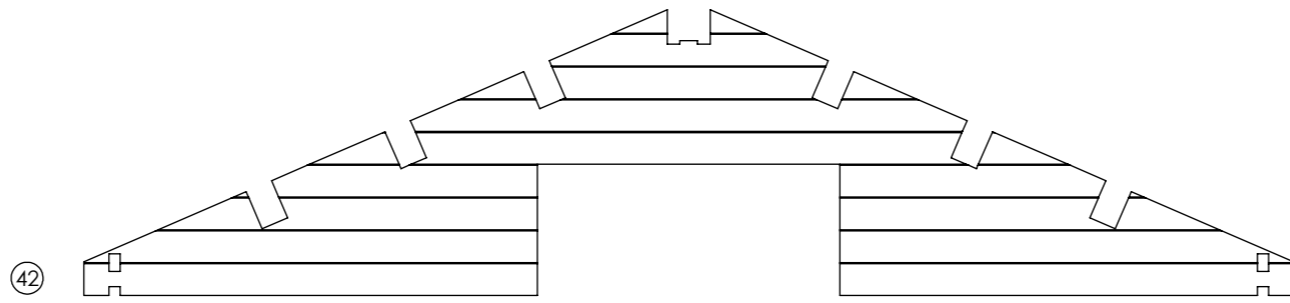
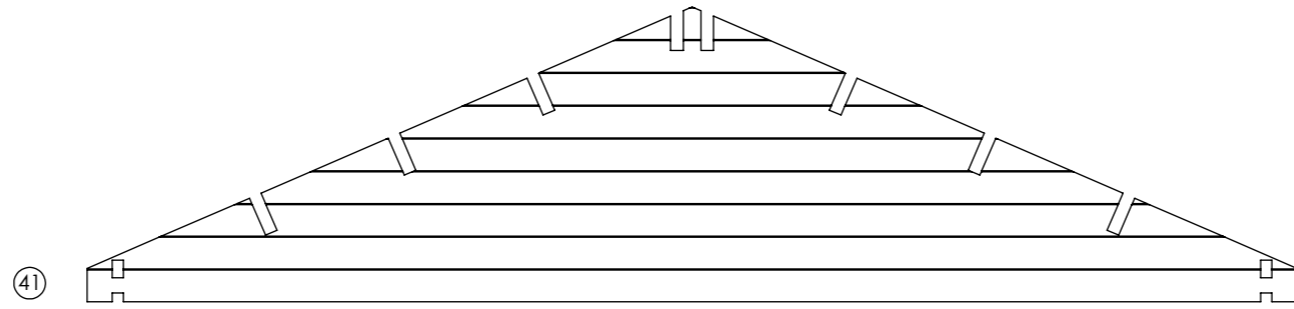

Date	2022-07-27 08:48:24
------	------------------------

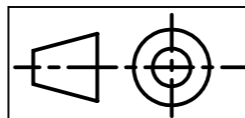

G	Sheet 4-9
---	-----------

2022-07-27 08:48:24	Date
------------------------	------

20273 Marten 30 (44)(W) Kaj. P

POS. NO.	QTY.	Description	LONGUEUR
44	13	FLOOR JOINTS 60x180	4480
45	4	FLOOR JOINTS 60x180	3250
46	45	FLOORBOARD 28x100	4063
47	90	FLOORBOARD 28x100	2295
48	4	WINDBOARD 19x100	4638
49	8	WINDBOARD 19x100	3250
50	2	BEAM 28x50	4512
51	1	PLINTH 19x50	50 m

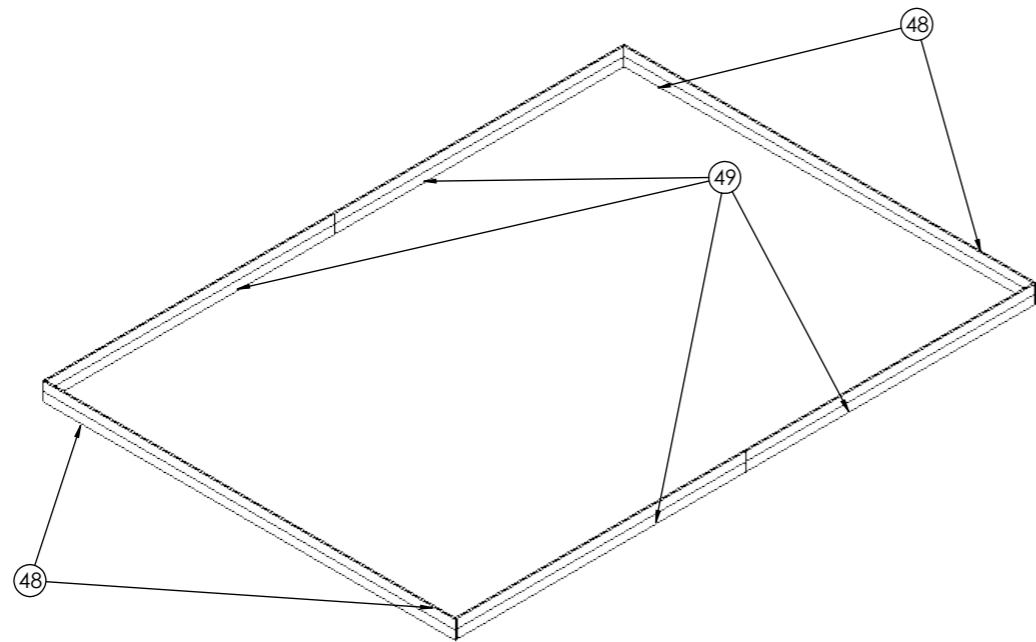
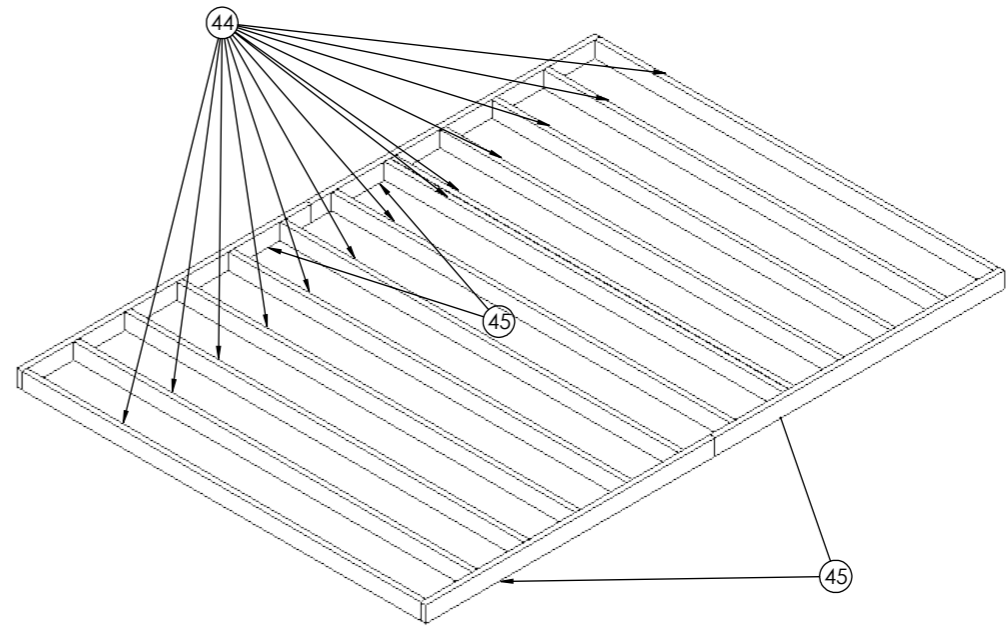
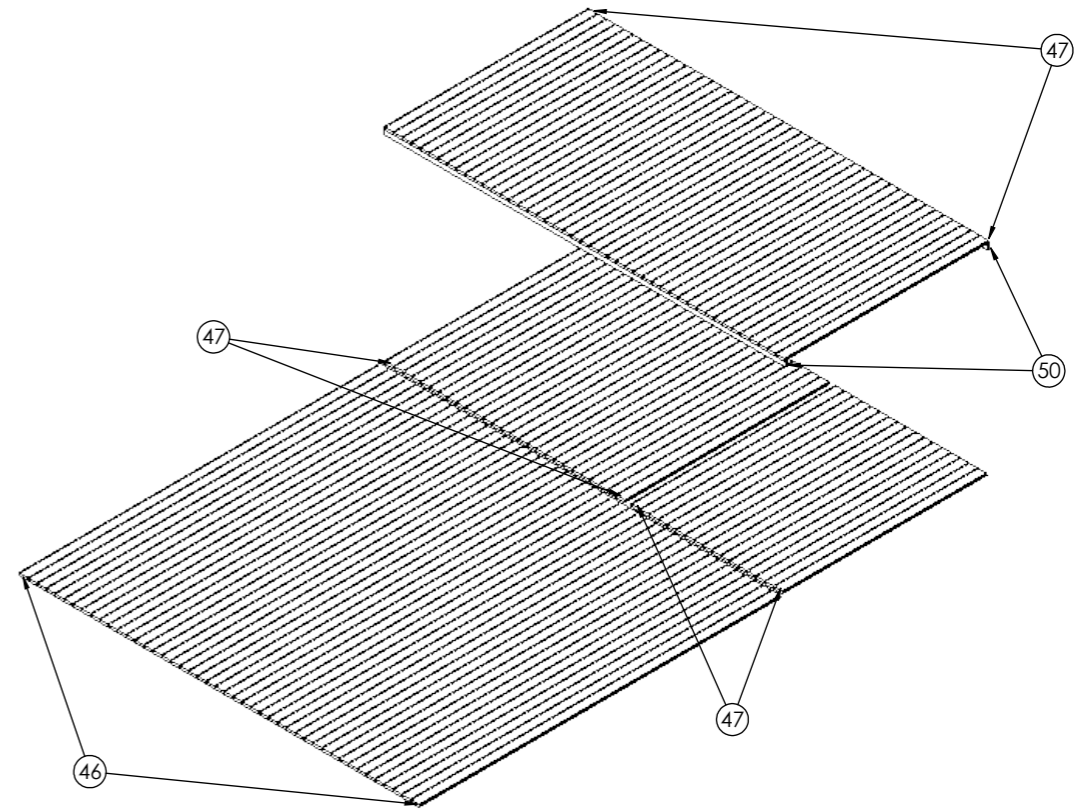

Date  
2022-07-26  
16:46:35

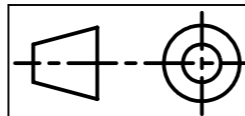



G	Sheet 1-1	2022-07-26 16:46:35	20273 Marten 30 (44)(F) Kaj. P	8/14 A3
		Date		Pack list 44-51 (4/5)

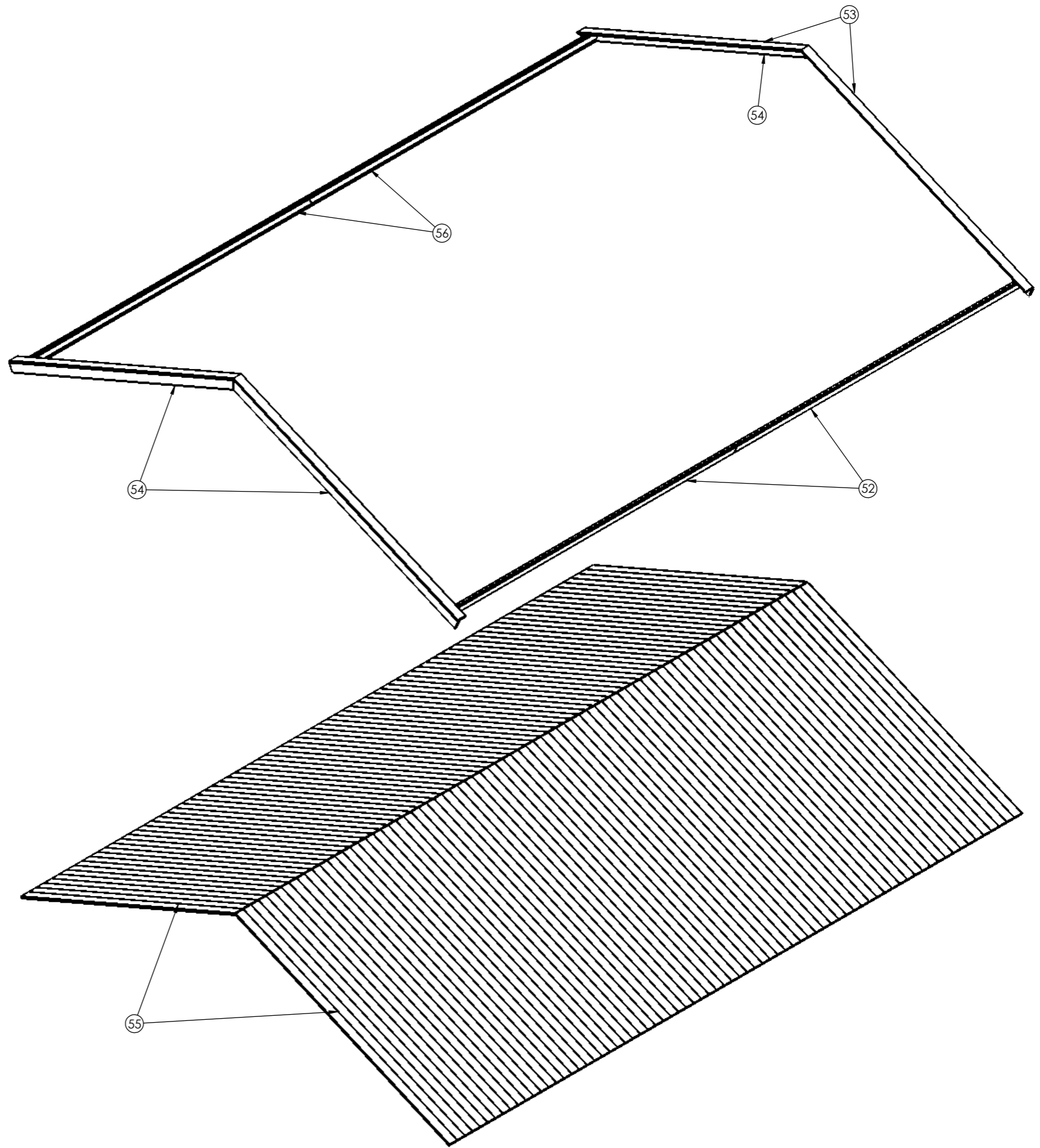

POS. NO.	QTY.	Description	LONGUEUR
52	4	WINDBOARD 19x100	3750
53	4	WINDBOARD 19x100	3200
54	4	WINDBOARD 19x100	3200
55	150	ROOF BOARD 19x100	3050
56	4	BEAM 28x50	3750



Date	2022-07-26
	16:48:11

 	G	Sheet 1-1	2022-07-26 16:48:11	20273 Marten 30 (44)(R) Kaj. P	9/14 A3
			Date		Pack list 52-56 (5/5)



Date	2022-07-27
	08:48:24

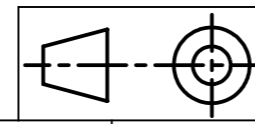

G	Sheet 5-9
---	-----------

2022-07-27	08:48:24
Date	

20273 Marten 30 (44)(W) Kaj. P

A

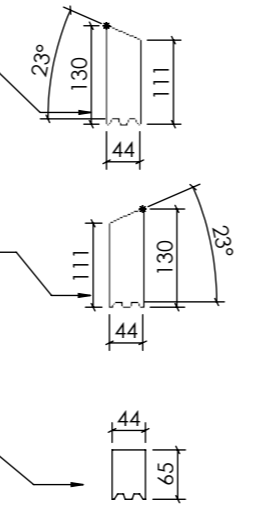
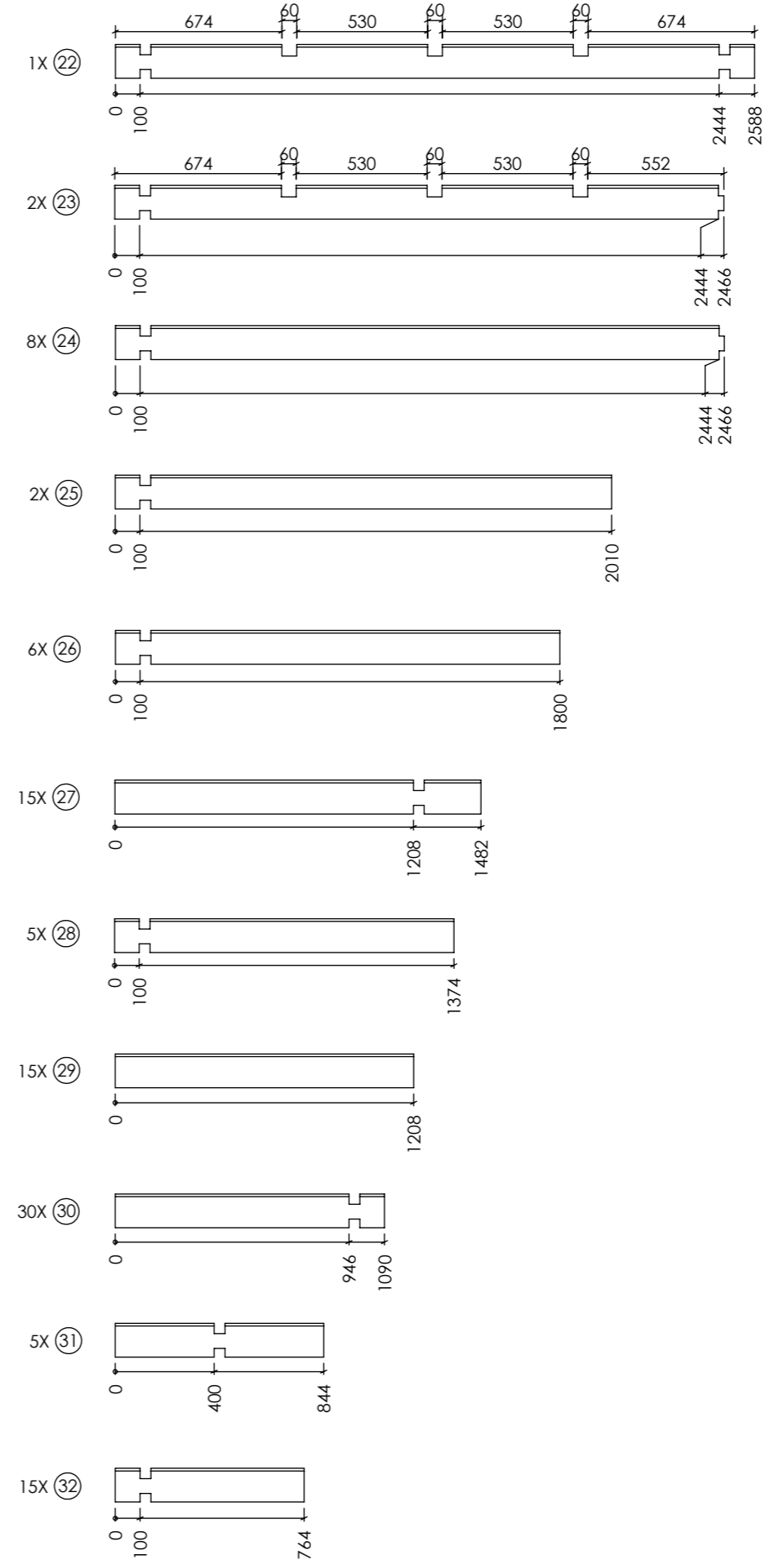
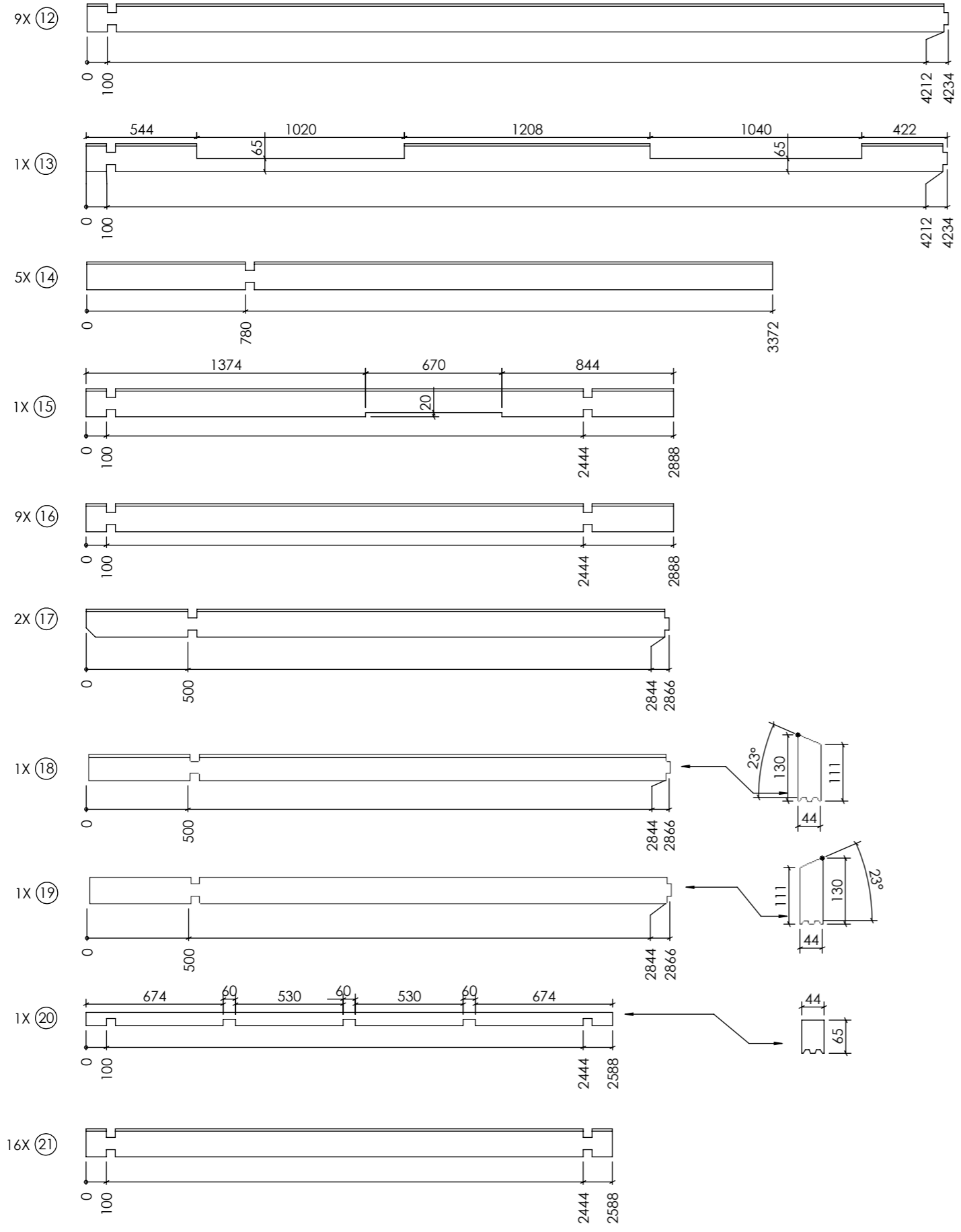

Date	2022-07-27
	08:48:24

G	Sheet 6-9	Date	2022-07-27
			08:48:24

20273 Marten 30 (44)(W) Kaj. P



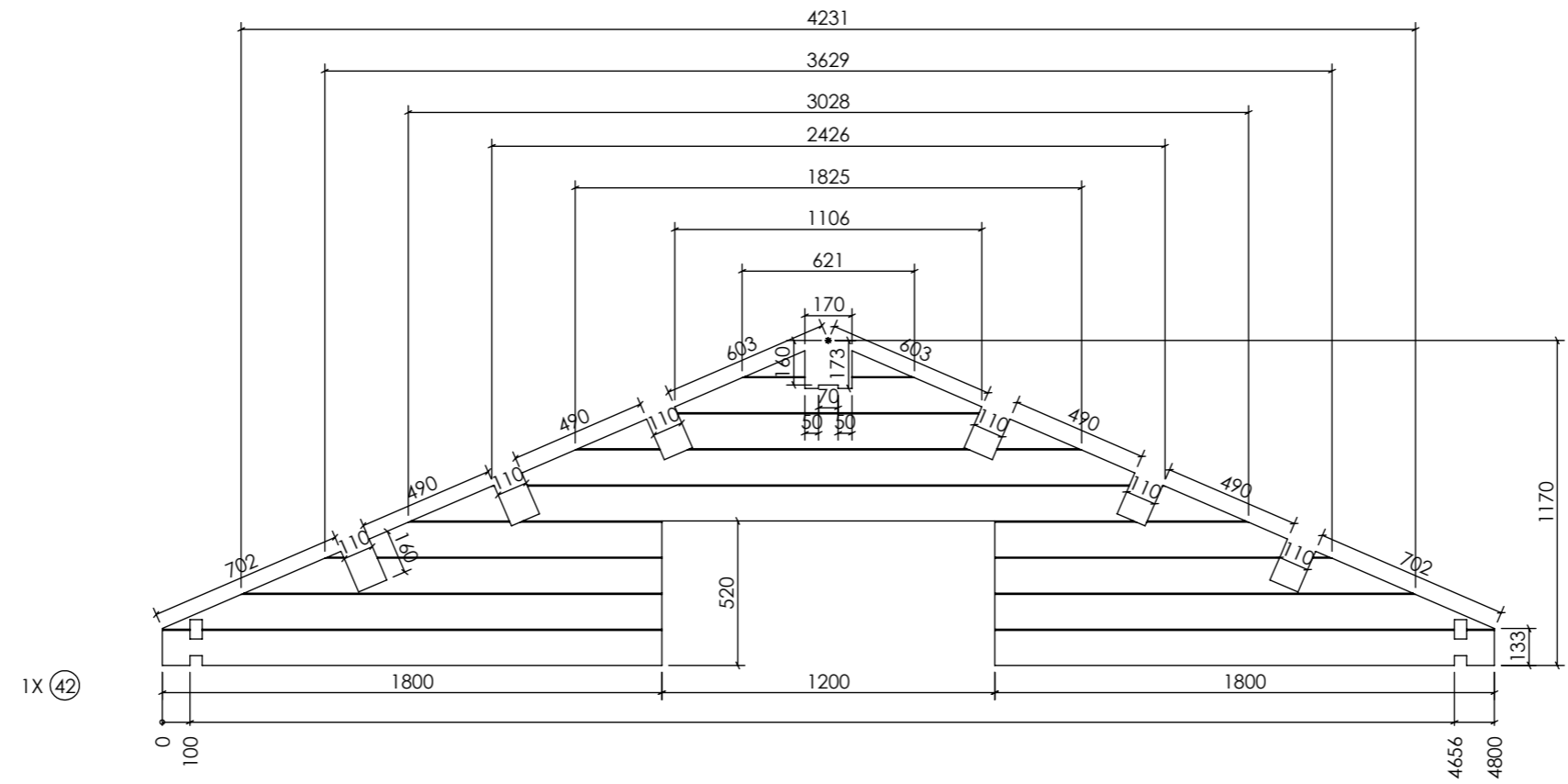
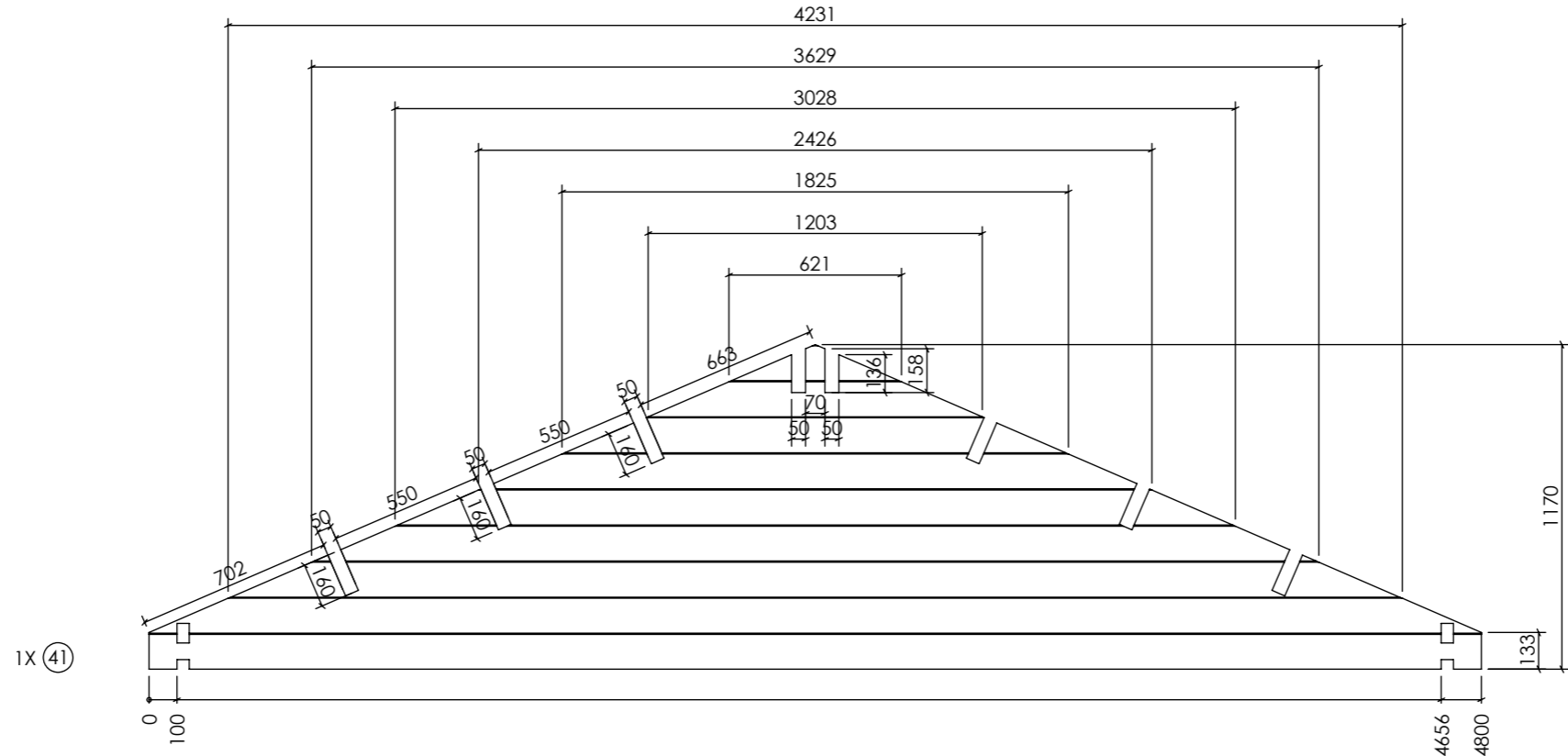

Date	2022-07-27
	08:48:24

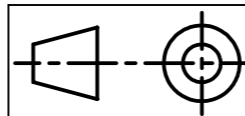

G	Sheet 8-9
---	-----------

2022-07-27	08:48:24
Date	

20273 Marten 30 (44)(W) Kaj. P

