

Wall 1

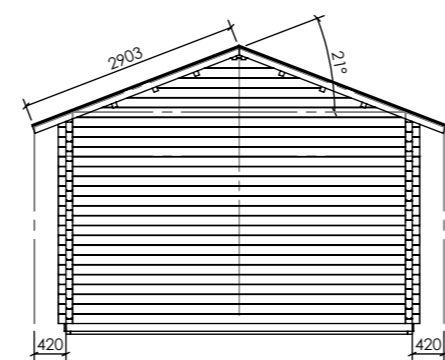

Wall A

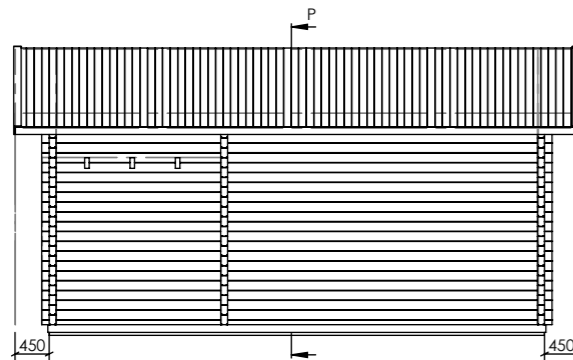

Wall 3

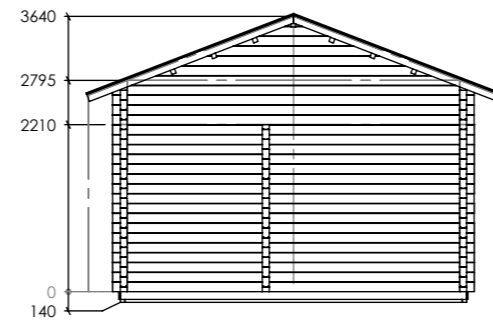

Wall C

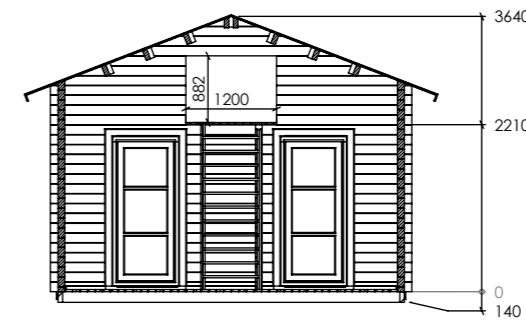

SECTION P-P

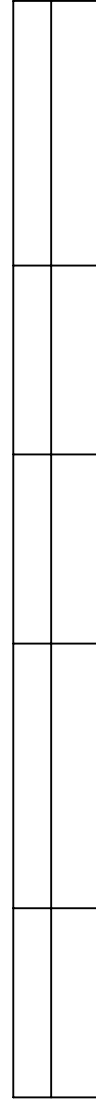
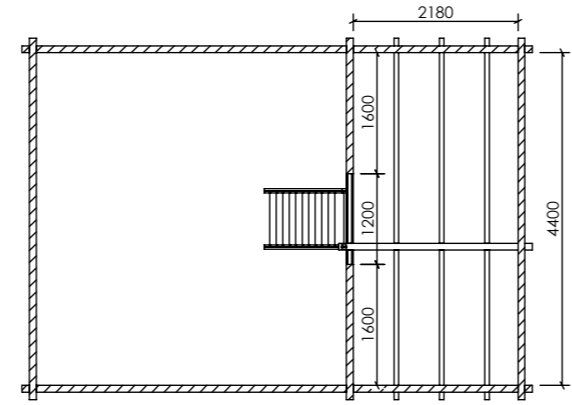
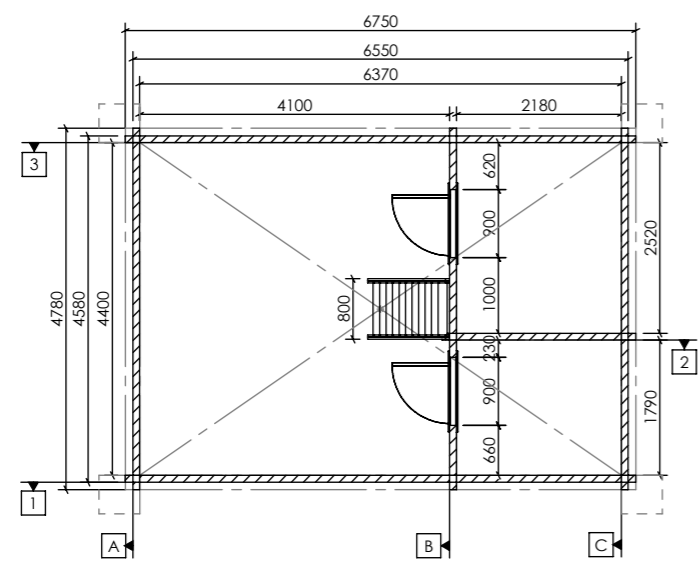

A

Timmerstomme 30 NB6645(90)

M 1:100 A3
 Facades/Plan